

6759 Supply Way
Boise, ID. 83716
Ph # 208-345-3844
Fax# 208-345-3790



5 Campbell Drive S.E.
Hermiston, Or. 97838
Toll Free 877-385-3125
Phone# 541-564-7636
Fax # 541-564-6522

Industrial Hose Clamps, Mounting Clamps & Tie Products Reference Catalog

7/13/2022

Worm Gear, Micro, Standard, Heavy, Lined, Snap lock, T-Bolts, Standard, All SS, Spring Pg. 2-6



Preformed-Punch, Roll over (JS), Tools, Strapping & Buckles Pg's 6-9



Heavy Duty Mikalor T-bolts, Double Bolts, Spiral, Pinch Clamps in Single & Double Ear Pg's 9-14

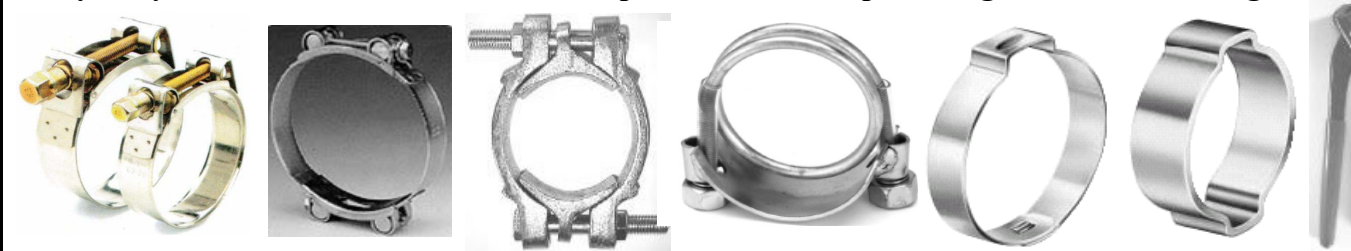

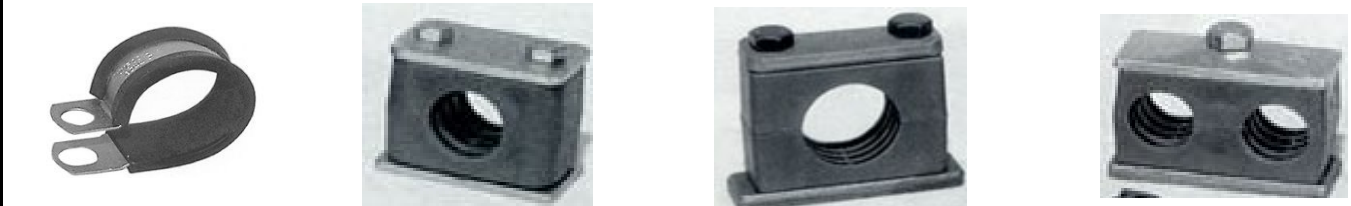

Mounting Clamps Cushioned, Weldable in Standard, Heavy & Twin Pg's 14-17

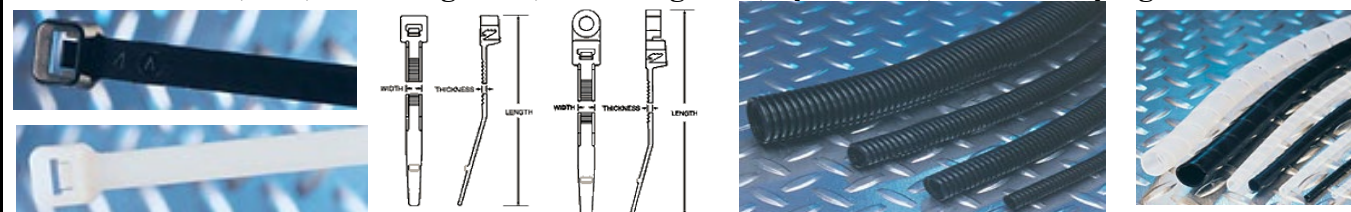

Cable Ties-Black, Nat, Mounting holes, Mounting Pads, Split Loom, Cable Wrap Pg's 18-19



CLAMPS

CLAMPS				
NORTON CLAMPS MADE IN THE USA				
WORM GEAR CLAMPS	Bagged			
300 SS band & Screw	MARINE GRADE			
Marine Grade Clamp	SIZE RANGE			
Mini	5/16 band			Bagged
NA3M04-1	7/32" X 5/8"			
NA3M06-1	7/16" X 27/32"			
Marine Grade Clamp	SIZE RANGE			
Standard	1/2 band			Bagged
NA3S06-1	7/16 x 25/32			
NA3S08-1	1/2 x 29/32			
NA3S10-1	9/16 x 11/16			
NA3S12-1	11/16 x 1 1/4			
NA3S16-1	13/16 x 1 1/2			
NA3S20-1	13/16 x 1 3/4			
NA3S24-1	1 1/16 x 2			
NA3S28-1	1 5/16 x 2 1/4			
NA3S32-1	1 9/16 x 2 1/2			
NA3S36-1	1 13/16 x 2 3/4			
NA3S40-1	2 1/16 X 3			
NA3S44-1	2 5/16 x 3 1/4			
NA3S48-1	2 9/16 x 3 1/2			
NA3S52-1	2 13/16 x 3 3/4			
NA3S56-1	3 1/16 x 4			
NA3S60-1	3 5/16 x 4 1/4			
NA3S64-1	3 9/16 x 4 1/2			
NA3S72-1	1 7/8 x 5			
NA3S80-1	2 1/2 x 5 1/2			
NA3S88-1	3 1/8 x 6			
NA3S96-1	3 5/8 x 6 1/2			
NA3S104-1	61/8 x 7			
NA3S116-1	513/16 x 711/16			
NA3S128-1	75/8 x 8 1/2			
NA3S152-1	75/8 x 10			
NA3S164-1	97/8 x 10 3/4			
NA3S188-1	97/8 x 12 1/2			
NA3S192-1	10 7/8 x 13			
NA3S208-1	11 1/2 x 13 1/2			
NA3S212-1	10 3/4 x 13 11/16			

**Heavy Duty Buckle for
Higher Torque**

**Heavy Duty Buckle for
Higher Torque**

NA3S224-1	11 1/2 x 14 7/16				
NA3S236-1	12 1/4 x 15 3/16				
NA3S248-1	13/4 x 15 15/16				
NA3S272-1	15 1/2 x 17 7/16				
NA3S312-1	18 x 20				
NA3S332-1	19-1/4 x 21-1/4				
NA3S390-1	14-1/2 x 25				
NA3S502-1	28 x 32				
NA3S538-1	24-3/4 x 34-1/4				
NA3S569-1	32 x 36-1/4				
Lined Clamps for Silicone Hose					Bagged
NA3SL08-1	1/2 x 29/32				
NA3SL10-1	9/16 x 11/16				
NA3SL12-1	11/16 x 1 1/4				
NA3SL16-1	13/16 x 1 1/2				
NA3SL20-1	13/16 x 1 3/4				
NA3LS24-1	1 1/16 x 2				
NA3LS28-1	1 5/16 x 2 1/4				
NA3LS32-1	1 9/16 x 2 1/2				
NA3LS36-1	1 13/16 x 2 3/4				
NA3LS40-1	2 1/16 X 3				
NA3LS60-1	3 5/16 x 4 1/4				
NORTON CLAMPS MADE IN THE USA					
WORM GEAR CLAMPS		BOXED			
300 SS band & Screw		MARINE GRADE			
Marine Grade Clamp		SIZE RANGE			
Mini		5/16 band			BOX 10
NA3M04	7/32" X 5/8"				
NA3M06	7/16" X 27/32"				
NA3M08	1/2" X 1"				
NA3M10	1/2" X 1 1/16"				
BOXED					
Marine Grade Clamp		SIZE RANGE			
Standard		1/2 band			BOX 10
NA3S06	7/16 x 25/32				
NA3S08	1/2 x 29/32				
NA3S10	9/16 x 11/16				
NA3S12	11/16 x 1 1/4				
NA3S16	13/16 x 1 1/2				
NA3S20	13/16 x 1 3/4				
NA3S24	1 1/16 x 2				

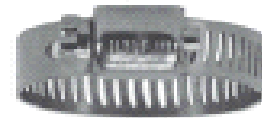

**Heavy Duty Buckle for
Higher Torque**

NA3S28	1 5/16 x 2 1/4				
NA3S32	1 9/16 x 2 1/2				
NA3S36	1 13/16 x 2 3/4				
NA3S40	2 1/16 X 3				
NA3S44	2 5/16 x 3 1/4				
NA3S48	2 9/16 x 3 1/2				
NA3S52	2 13/16 x 3 3/4				
NA3S56	3 1/16 x 4				
NA3S60	3 5/16 x 4 1/4				
NA3S64	3 9/16 x 4 1/2				
NA3S72	1 7/8 x 5				
NA3S80	2 1/2 x 5 1/2				
NA3S88	3 1/8 x 6				
NA3S96	3 5/8 x 6 1/2				
NA3S104	61/8 x 7				
Ideal 63series in long lgths. With a wide size range					
63128	2 1/2" x 8 1/2"				
63152	2-1/2" x 10"				
63164	2-1/2 x 10-3/4"				
63188	2-1/2" x 12 1/4"				
63244	2-1/2 x 14-1/2"				
63248	2-1/2 x 16"				
63260	2-1/2 x 16-3/4"				
63272	2-1/2 x 17-1/2"				
63312	2-1/2 x 20"				
63380	2-1/2 x 24-1/4"				
63760	2-1/2 x 48"				
Ideal Quick Release SS band plated screw					
56128	2 1/4" x 8 1/2"				
56152	2" x 10"				
56188	2" x 12 1/4"				
56232	2" x 15"				
56288	2" x 18 1/2"				
56332	2" x 21 1/4"				



T-Bolt Clamps

3/4SS Band & Plated Bolt	Size Range	Ideal #	Max. Torq 90lbs Dry	
TB-131C	1.25" x 1.41"			
TB-150C	1.34" x 1.56"			
TB-163C	1.47" x 1.69"			
TB-175C	1.59" x 1.81"			
TB-188C	1.72" x 1.94"			
TB-200C	1.84" x 2.06"			
TB-212C	1.96" X 2.18"			
TB-225C	2.09" x 2.31"			
TB-238C	2.22" x 2.44"			
TB-250C	2.34" x 2.56"			
TB-256C	2.33" x 2.62"			
TB-263C	2.40" x 2.69"			
TB-275C	2.52" x 2.81"			
TB-288C	2.65" x 2.94"			
TB-300C	2.77" x 3.06"			
TB-312C	2.87" x 3.18"			
TB-325C	3.02" x 3.31"			
TB-338C	3.16" x 3.45"			
TB-350C	3.28" x 3.56"			
TB-362C	3.39" x 3.68"			
TB-375C	3.52" x 3.81"			
TB-382C	3.59" x 3.88"			
TB-400C	3.77" x 4.06"			
TB-413C				
TB-425C	4.0" x 4.31"			
TB-438C	4.12" x 4.47"			
TB-450C	4.27" x 4.56"			
TB-475C	4.52" x 4.8"			
TB-500C	4.77" x 5.06"			
TB-525C	5.02" x 5.31"			
TB-550C	5.27" x 5.56"			
TB-575C	5.52" x 5.81"			
TB-600C	5.77" x 6.06"			
TB-612C	5.87" x 6.21"			
TB-625C	6.03" x 6.31"			
TB-650C	6.27" x 6.56"			
TB-656C	6.32" x 6.61"			
TB-675C	6.52" x 6.81"			
TB-700C	6.77" x 7.06"			
TB-725C	7.02" x 7.31"			
TB-750C	7.27" x 7.56"			
TB-800C	7.77" x 8.06"			
TB-825C	8.02" x 8.31"			
TB-850C	8.27" x 8.56"			

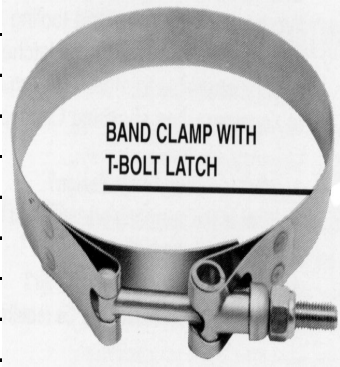
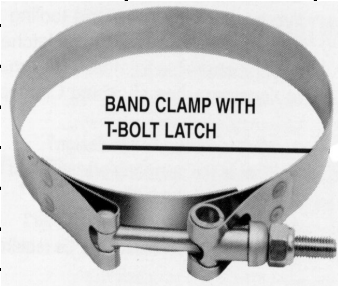

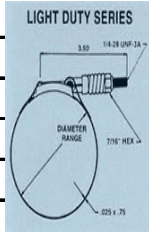
TB-888C		8.65" x 8.94"				
TB-900C		8.77" x 9.06"				
TB-950C		9.27" x 9.56"				
TB-1000C		9.77" x 10.06"				
TB-1088C		10.65" x 10.94"				
TB-1288C		12.65" x 12.94"				
Boot Clamp Thicker 7/8SS Ba		7/.65" x 7/.94"	Ideal #			
72565/8	SAE#196	72.65" x 72.94"	700			
Spring Loaded Constant Pres		Bo.65" x Bo.94"	Ideal #	SS Band & Plated bolt		
238-SPR		SP.65" x SP.94"				
269-SPR	SAE#	2.47" x 2.78"				
325-SPR		SP.65" x SP.94"				
338-SPR		SP.65" x SP.94"				
350-SPR		SP.65" x SP.94"				
375-SPR	SAE#	3.56" x 3.88"	356			
412-SPR		SP.65" x SP.94"				
428-SPR	SAE#	4.06" x 4.37"	403			
440-SPR	SAE#	4.14" x 4.49"				
466-SPR	SAE#	4.44" x 4.75"				
560-SPR	SAE#	5.37" x 5.69"				
672-SPR	SAE#	6.49" x 6.81"				
772-SPR	SAE#	7.49" x 7.79"				
3/4 SS Band & Bolt T-BOLT		Size Range	Ideal #	Max. Torque 75lbs Dry		
TB-SS131C		1.25" x 1.41"				
TB-SS150C		1.34" x 1.56"				
TB-SS163C		1.47" x 1.69"				
TB-SS175C		1.59" x 1.81"				
TB-SS188C		1.72" x 1.94"				
TB-SS200C		1.84" x 2.06"				
TB-SS212C		1.96" X 2.18"				
TB-SS225C		2.09" x 2.31"				
TB-SS238C		2.22" x 2.44"				
TB-SS250C		2.34" x 2.56"				
TB-SS256C		2.33" x 2.62"				
TB-SS263C		2.40" x 2.69"				
TB-SS275C		2.52" x 2.81"				
TB-SS288C		2.65" x 2.94"				
TB-SS300C		2.77" x 3.06"				
TB-SS312C		2.87" x 3.18"				
TB-SS325C		3.02" x 3.31"				
TB-SS350C		3.27" x 3.56"				
TB-SS362C		3.28" x 3.56"				
TB-SS375C		3.52" x 3.81"				
TB-SS382C		3.59" x 3.88"				
TB-SS400C		3.52" x 3.88"				
TB-SS425C		3.77" x 4.06"				
TB-SS450C		4.27" x 4.56"				

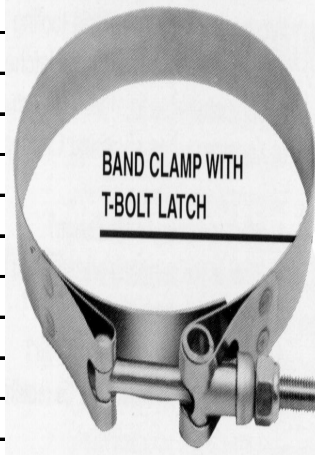



TB-SS475C	4.52" x 4.8"			
TB-SS500C	4.77" x 5.06"			
TB-SS525C	5.02" x 5.31"			
TB-SS538C	5.27" x 5.56"			
TB-SS550C	5.52" x 5.81"			
TB-SS575C	5.77" x 6.06"			
TB-SS600C	5.87" x 6.21"			
TB-SS625C	6.03" x 6.31"			
TB-SS650C	6.27" x 6.56"			
TB-SS675C	6.32" x 6.61"			
TB-SS700C	6.52" x 6.81"			
TB-SS725C	6.77" x 7.06"			
TB-SS750C	7.02" x 7.31"			
TB-SS800C	7.27" x 7.56"			
TB-SS825C	7.77" x 8.06"			
TB-SS850C	8.02" x 8.31"			
TB-SS856C	8.27" x 8.56"			
TB-SS888C	8.65" x 8.94"			
TB-SS900C	8.77" x 9.06"			
TB-SS950C	9.27" x 9.56"			
TB-SS1000C	9.77" x 10.06"			
TB-SS1088C	10.65" x 10.94"			
TB-SS1200C	11.77" x 12.06"			
TB-SS1288C	12.65" x 12.94"			



Mikalor Heavy Duty Clamps T Bolt Double bolt, 4 bolt Clamps

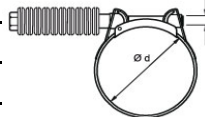

W4 SERIES SS BAND PLATED SINGLE BOLT					
075MIK-W2		0.67x0.75	725HPSI		
080MIK-W2		0.75x0.83	725HPSI		
085MIK-W2		0.83x0.91	696HPSI		
100MIK-W2		0.91x0.98	696HPSI		
105MIK-W2		0.98x1.06	652HPSI		
110MIK-W2		1.06x1.14	652HPSI		
120MIK-W2		1.14x1.22	667HPSI		
125MIK-W2		1.22x1.34	667HPSI		
140MIK-W2		1.34x1.46	667HPSI		
150MIK-W2		1.46x1.57	638HPSI		
165MIK-W2		1.58x1.69	638HPSI		
175MIK-W2		1.69x1.85	638HPSI		
200MIK-W2		1.85x2.01	638HPSI		
210MIK-W2		2.01x2.17	580HPSI		
225MIK-W2		2.17x2.32	580HPSI		
238MIK-W2		2.32x2.48	522HPSI		
250MIK-W2	2.48x2.68	522HPSI			
275MIK-W2	2.68x2.87	406HPSI			
300MIK-W2	2.87x3.11	406HPSI			
325MIK-W2	3.11x3.35	406BPSI			
350MIK-W2	3.35x3.58	290BPSI			

375MIK-W2		3.58x3.82 290BPSI			
400MIK-W2		3.82x4.10 290BPSI			
425MIK-W2		4.10x4.41 174BPSI			
450MIK-W2		4.41x4.78 174BPSI			
500MIK-W2		4.76-5.11 174BPSI			
525MIK-W2		5.11x5.51 131BPSI			
575MIK-W2		5.51x5.91 131BPSI			
600MIK-W2		5.91x6.38 131BPSI			
650MIK-W2		6.38x6.85 87BPSI			
700MIK-W2		6.85x7.36 87BPSI			
750MIK-W2		7.38x7.87 44BPSI			
800MIK-W2		7.87x8.13 44BPSI			
850MIK-W2		8.13x8.89 44BPSI			
900MIK-W2		8.89x9.41 44TQPSI			
950MIK-W2		9.41x9.92 44TQPSI			
1000MIK-W2		9.92x10.43 44TQPSI			
1050MIK-W2					
1075MIK-W2		10.43x10.75 44TQPSI			
1275MIK-W2		12.50x13.00 44TQPSI			
W4 SS BAND SS S. BOLT					
075MIK-SSW4		0.67x0.75 725TQPSI			
080MIK-SSW4		0.75x0.83 725TQPSI			
085MIK-SSW4		0.83x0.91 696TQPSI			
100MIK-SSW4		0.91x0.98 696TQPSI			
105MIK-SSW4		0.98x1.06 652TQPSI			
110MIK-SSW4		1.06x1.14 652TQPSI			
120MIK-SSW4		1.14x1.22 667TQPSI			
125MIK-SSW4		1.22x1.34 667TQPSI			
140MIK-SSW4		1.34x1.46 667TQPSI			
150MIK-SSW4		1.46x1.57 638TQPSI			
165MIK-SSW4		1.58x1.69 638TQPSI			
175MIK-SSW4		1.69x1.85 638TQPSI			
200MIK-SSW4		1.85x2.01 638TQPSI			
210MIK-SSW4		2.01x2.17 580TQPSI			
225MIK-SSW4		2.17x2.32 580TQPSI			
238MIK-SSW4		2.32x2.48 522TQPSI			
250MIK-SSW4		2.48x2.68 522TQPSI			
275MIK-SSW4		2.68x2.87 406TQPSI			
300MIK-SSW4		2.87x3.11 406TQPSI			
325MIK-SSW4	3.11x3.35 406TQPSI				
350MIK-SSW4	3.35x3.58 290TQPSI				
375MIK-SSW4	3.58x3.82 290TQPSI				
400MIK-SSW4	3.82x4.10 290TQPSI				
425MIK-SSW4	4.10x4.41 174TQPSI				
450MIK-SSW4	4.41x4.78 174TQPSI				
500MIK-SSW4	4.76-5.11 174TQPSI				
525MIK-SSW4	5.11x5.51 131TQPSI				

575MIK-SSW4	5.51x5.91 131TQPSI				
600MIK-SSW4	5.91x6.38 131TQPSI				
650MIK-SSW4	6.38x6.85 87TQPSI				
700MIK-SSW4	6.85x7.36 87TQPSI				
750MIK-SSW4	7.38x7.87 44TQPSI				
800MIK-SSW4	7.87x8.13 44TQPSI				
850MIK-SSW4	8.13x8.89 44TQPSI				
900MIK-SSW4	8.89x9.41 44TQPSI				
950MIK-SSW4	9.41x9.92 44TQPSI				
CONSTANT TENSION SS BAND PLATED SINGLE BOLT					
075MIK-SPR		0.67x0.75 725TQPSI			
080MIK-SPR		0.75x0.83 725TQPSI			
085MIK-SPR		0.83x0.91 696TQPSI			
100MIK-SPR		0.91x0.98 696TQPSI			
105MIK-SPR		0.98x1.06 652TQPSI			
110MIK-SPR		1.06x1.14 652TQPSI			
120MIK-SPR		1.14x1.22 667TQPSI			
125MIK-SPR		1.22x1.34 667TQPSI			
140MIK-SPR		1.34x1.46 667TQPSI			
150MIK-SPR		1.46x1.57 638TQPSI			
165MIK-SPR		1.58x1.69 638TQPSI			
175MIK-SPR		1.69x1.85 638TQPSI			
200MIK-SPR		1.85x2.01 638TQPSI			
210MIK-SPR		2.01x2.17 580TQPSI			
225MIK-SPR		2.17x2.32 580TQPSI			
238MIK-SPR		2.32x2.48 522TQPSI			
250MIK-SPR		2.48x2.68 522TQPSI			
275MIK-SPR		2.68x2.87 406TQPSI			
300MIK-SPR		2.87x3.11 406TQPSI			
325MIK-SPR		3.11x3.35 406TQPSI			
350MIK-SPR		3.35x3.58 290TQPSI			
375MIK-SPR		3.58x3.82 290TQPSI			
400MIK-SPR		3.82x4.10 290TQPSI			
425MIK-SPR		4.10x4.41 174TQPSI			
450MIK-SPR		4.41x4.78 174TQPSI			
500MIK-SPR		4.76-5.11 174TQPSI			

525MIK-SPR		5.11x5.51 131TQPSI			
575MIK-SPR		5.51x5.91 131TQPSI			
600MIK-SPR		5.91x6.38 131TQPSI			
650MIK-SPR		6.38x6.85 87TQPSI			
700MIK-SPR		6.85x7.36 87TQPSI			
750MIK-SPR		7.38x7.87 44TQPSI			
800MIK-SPR		7.87x8.13 44TQPSI			
850MIK-SPR		8.13x8.89 44TQPSI			
900MIK-SPR		8.89x9.41 44TQPSI			
950MIK-SPR		9.41x9.92 44TQPSI			
CONSTANT TENS SS BAND SS S. BOLT					
165MIK-SPRSS		1.58x1.69 638TQPSI			
175MIK-SPRSS		1.69x1.85 638TQPSI			
200MIK-SPRSS		1.85x2.01 638TQPSI			
210MIK-SPRSS		2.01x2.17 580TQPSI			
225MIK-SPRSS		2.17x2.32 580TQPSI			
238MIK-SPRSS		2.32x2.48 522TQPSI			
250MIK-SPRSS		2.48x2.68 522TQPSI			
275MIK-SPRSS		2.68x2.87 406TQPSI			
300MIK-SPRSS		2.87x3.11 406TQPSI			
325MIK-SPRSS		3.11x3.35 406TQPSI			
350MIK-SPRSS		3.35x3.58 290TQPSI			
375MIK-SPRSS		3.58x3.82 290TQPSI			
400MIK-SPRSS		3.82x4.10 290TQPSI			
425MIK-SPRSS		4.10x4.41 174TQPSI			
450MIK-SPRSS		4.41x4.78 174TQPSI			
500MIK-SPRSS		4.76-5.11 174TQPSI			
525MIK-SPRSS		5.11x5.51 131TQPSI			
575MIK-SPRSS		5.51x5.91 131TQPSI			
600MIK-SPRSS		5.91x6.38 131TQPSI			
650MIK-SPRSS		6.38x6.85 87TQPSI			
700MIK-SPRSS		6.85x7.36 87TQPSI			
750MIK-SPRSS		7.38x7.87 44TQPSI			
800MIK-SPRSS		7.87x8.13 44TQPSI			
850MIK-SPRSS		8.13x8.89 44TQPSI			
900MIK-SPRSS		8.89x9.41 44TQPSI			
950MIK-SPRSS		9.41x9.92 44TQPSI			
RC-Double Plated Bolt Steel Band		Size Range			
RC-300-DB		3.071" x 3.465"			
RC-400-DB		4.095" x 5.00"			
RC-600-DB		5.591" x 7.300"			
RC-800-DB		7.913" x 8.400"			

Center Punch Clamps					
PUNCH-CLAMP					
GALVANIZED PUNCHLOK	Clamp Width x I.D.				
BCP3	3/8"w x 13/16"I.D.				
BCP311	3/8"w x 13/8"I.D.				
BCP4	5/8"w x 1"I.D.				
BCP5	5/8"w x 11/4"I.D.				
BCP6	5/8"w x 11/2"I.D.				
BCP7	5/8"w x 13/4"I.D.				
BCP8	5/8"w x 2"I.D.				
BCP9	5/8"w x 21/4"I.D.				
	Clamp Width x I.D.				
BCP10	5/8"w x 21/2"I.D.				
BCP11	5/8"w x 23/4"I.D.				
BCP12	5/8"w x 3"I.D.				
BCP14	5/8"w x 31/2"I.D.				
	Clamp Width x I.D.				
BCP16	5/8"w x 4"I.D.				
BCP18	5/8"w x 41/2"I.D.				
BCP20	5/8"w x 5"I.D.				
BCP24	5/8"w x 6"I.D.				
	Clamp Width x I.D.				
BCP28	5/8"w x 7"I.D.				
BCP32	5/8"w x 8"I.D.				
Industrial Choice Punch Clamp					
Stainless Steel Punch Clamp	Clamp Width x I.D.				
IC-PC3SS	3/8"w x 13/16"I.D.				
IC-PC311SS	3/8"w x 13/8"I.D.				
IC-PC4SS	5/8"w x 1"I.D.				
IC-PC5SS	5/8"w x 11/4"I.D.				
IC-PC6SS	5/8"w x 11/2"I.D.				
IC-PC7SS	5/8"w x 13/4"I.D.				
IC-PC8SS	5/8"w x 2"I.D.				
IC-PC9SS	5/8"w x 21/4"I.D.				
	Clamp Width x I.D.				
IC-PC10SS	5/8"w x 21/2"I.D.				
IC-PC11SS	5/8"w x 23/4"I.D.				
IC-PC12SS	5/8"w x 3"I.D.				
IC-PC14SS	5/8"w x 31/2"I.D.				
	Clamp Width x I.D.				
IC-PC16SS	5/8"w x 4"I.D.				
IC-PC18SS	5/8"w x 41/2"I.D.				
IC-PC20SS	5/8"w x 5"I.D.				
IC-PC24SS	5/8"w x 6"I.D.				

		Clamp Width x I.D.				
IC-PC26SS		5/8"w x 61/2"I.D"				
IC-PC28SS		5/8"w x 7"I.D.				
IC-PC32SS		5/8"w x 8"I.D.				
TOOLS						
T300						
S038						
J020						
D-550		CLAMP CUTTER				
JS SERIES CLAMPS						
GALVANIZED		Clamp Width x I.D.				
JS301		3/8"w x 13/16"I.D.				
JS343		3/8"w x 1"I.D.				
JS302		3/8"w x 13/8"I.D.				
JS303		1/2"w x 1"I.D.				
JS304		1/2"w x 11/4"I.D.				
JS305		5/8"w x 11/2"I.D.				
JS306		5/8"w x 13/4"I.D.				
JS307		5/8"w x 2"I.D.				
JS308		5/8"w x 21/4"I.D.				
JS309		5/8" x 21/2"I.D.				
			Clamp Width x I.D.			
JS310			3/4" x 23/4"I.D.			
JS311		3/4" x 3"I.D.				
JS312		3/4" x 31/2"I.D.				
		Clamp Width x I.D.				
JS313		3/4" x 4"I.D.				
JS314		3/4" x 41/2"I.D.				
JS315		3/4" x 5"I.D.				
JS SERIES CLAMPS						
STAINLESS STEEL		Clamp Width x I.D.				
JS201		3/8"w x 13/16"I.D.				
JS243		3/8"w x 1"I.D.				
JS202		3/8"w x 13/8"I.D.				
JS203		1/2"w x 1"I.D.				
JS204		1/2"w x 11/4"I.D.				
JS205		5/8"w x 11/2"I.D.				
JS206		5/8"w x 13/4"I.D.				
JS207		5/8"w x 2"I.D.				
JS208		5/8"w x 21/4"I.D.				
JS209		5/8" x 21/2"I.D.				
			Clamp Width x I.D.			
JS210			3/4" x 23/4"I.D.			
JS211		3/4" x 3"I.D.				
JS212		3/4" x 31/2"I.D.				

	Clamp Width x I.D.			
JS213	3/4" x 4"I.D.			
JS214	1/4" x 41/2"I.D.			
JS215	3/4" x 5"I.D.			
JS216	3/4" x 6"I.D.			
JS218	3/4" x 7"I.D.			
JS219	3/4" x 8"I.D.			



The smooth inside diameter produces a uniform clamping surface to prevent leak paths while the lower profile reduces the risk of snags when dragging industrial hose assemblies.



Industrial Choice Ultimate-Lock Band Clamp

Double wrapped, thick 201SS extra strength band clamp. Specialized lock, locks under full tension, minimize tension loss, providing the Ultimate Locking band clamp, The buckle is more than 2-3 as thick as Punch-Lok and JS series clamps. Smooth inside helps prevent leak paths.

Part #		Box Qty		
IC-ULC-08		100		
IC-ULC-10		50		
IC-ULC-11		50		
IC-ULC-12		25		
IC-ULC-13		25		
IC-ULC-14		25		
IC-ULC-15		25		
IC-ULC-16		25		
IC-ULC-17		25		
IC-ULC-18		25		
IC-ULC-19		25		
IC-ULC-28		10		
IC-ULC-32		10		

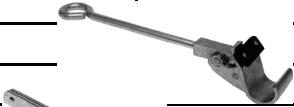

Industrial Choice SS Strapping-Tools-Buckles

TOOLS				
C001		Strapping Tool		
C002		JR Tool for J clamps		
C006	HANDLE	Handle for C001		
J001	J001	Adapter for JS clamps		

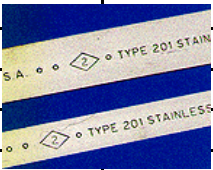

201 STAINLESS STEEL STRAPPING

IC-Strap-1/4x.30SS		1/4"		
IC-Strap-3/8x.30SS		3/8"		
IC-Strap-1/2x.30SS		1/2"		
IC-Strap-5/8x.30SS		5/8"		
IC-Strap-3/4x.30SS		3/4"		
IC-Strap-1/2x.20SS-200'		1/2"	200' Tote/Box	

BUCKLES

201 STAINLESS STEEL

IC-Buckles-1/4SS		1/4"		
IC-Buckles-3/8SS		3/8"		
IC-Buckles-1/2SS		1/2"		
IC-Buckles-5/8SS		5/8"		
IC-Buckles-3/4SS		3/4"		

Stainless Screw Buckles						
BuckleS-3/8-SS-SC723			3/8"			
Buckles-1/2-SS-SC724			1/2"			
Buckles-3/4-SS-SC726			3/4"			
Cast Iron Double bolt clamps			Clamp Range			
DB400			3.5" x 4"			
DB463			4.063" x 4.375"			
DB525			4.188" x 5"			
DB550			5" x 5.50"			
DB600			5.50" x 6.063"			
DB675			6.125" x 6.875"			
DB769			6.938" x 7.663"			
DB818			7.875" x 8.188"			
DB875			8.25" x 8.875"			
DB988			8.938" x 9.875"			
DB1125			11.188" x 13"			
DB1275			13.188" x 15"			
DB1450			15.063" x 17.50"			
SPIRAL CLAMP						
PART #						
S3000-2-C						
S3000-2-CC						
S3000-2.5-C						
S3000-2.5-CC						
S3000-3-C						
S3000-3-CC						
S3000-4-C						
S3000-4-CC						
S3000-5-C						
S3000-5-CC						
S3000-6-C						
S3000-6-CC						
S3000-8-C						
S3000-8-CC						
S3000-10-C						
S3000-10-CC						
S3000-12-C						
S3000-12-CC						

Oetiker Single Eared Pinch Clamps

Steel Galvanized					
PART #	Nom. Size x Size Range inches				
10500000 (105)	3/8" .350 x .414				
10500003 (133)	1/2" .453 x .524				
10500006 (140)	35/64" .472 x .551				
10500007 (145)	9/16" .496 x .571				
10500008 (157)	5/8" .543 x .618				
10500009 (170)	11/16" .549 x .669				
10500010 (185)	23/32" .618 x .728				
10500011 (198)	3/4" .669 x .779				
10500012 (210)	13/16" .716 x .827				
10500013 (226)	7/8" .779 x .890				
10500015 (256)	1" .898 x 1.008				
10500016 (271)	1 1/16" .945 x 1.067				
10500017 (286)	1 1/8" 1.004 x 1.126				
10500018 (301)	1 3/16" 1.063 x 1.185				
10500020 (331)	1 5/16" 1.181 x 1.303				
10500021 (346)	1 3/8" 1.240 x 1.362				
10500022 (361)	1 7/16" 1.299 x 1.421				
10500023 (376)	1 15/32" 1.358 x 1.480				
10500024 (381)	1 1/2" 1.378 x 1.500				
10500025 (396)	1 9/16" 1.437 x 1.559				
10500026 (410)	1 5/8" 1.492 x 1.614				
10500027 (425)	1 11/16" 1.551 x 1.673				
10500028 (440)	1 23/32" 1.610 x 1.732				
10500029 (455)	1 3/4" 1.669 x 1.791				
10500030 (470)	1 13/16" 1.728 x 1.850				
10500032 (500)	1 15/16" 1.846 x 1.968				
Stainless Steel					
PART #	Nom. Size x Size Range inches				
15500001 (105R)	3/8" .350 x .414				
15500003 (133R)	1/2" .453 x .524				
15500006 (140R)	35/64" .472 x .551				
15500007 (145R)	9/16" .496 x .571				
15500008 (157R)	5/8" .543 x .618				
15500009 (170R)	11/16" .549 x .669				
15500010 (185R)	23/32" .618 x .728				
15500011 (198R)	3/4" .669 x .779				
15500012 (210R)	13/16" .716 x .827				
15500013 (226R)	7/8" .779 x .890				
15500015 (256R)	1" .898 x 1.008				
15500016 (271R)	1 1/16" .945 x 1.067				
15500017 (286R)	1 1/8" 1.004 x 1.126				
15500018 (301R)	1 3/16" 1.063 x 1.185				
15500019 (316R)	1 5/16" 1.181 x 1.303				
15500020 (331R)	1 5/16" 1.240 x 1.362				



15500021 (346R)	1 3/8" 1.240 x 1.362				
15500022 (361R)	1 7/16" 1.299 x 1.421				
15500023 (376R)	1 15/32" 1.358 x 1.480				
15500024 (381R)	1 1/2" 1.378 x 1.500				
15500025 (396R)	1 9/16" 1.437 x 1.559				
15500026 (410R)	1 5/8" 1.492 x 1.614				
15500027 (425R)	1 11/16" 1.551 x 1.673				
15500028 (440R)	1 23/32" 1.610 x 1.732				
15500030 (470R)	1 13/16" 1.728 x 1.850				
15500032 (500R)	1 15/16" 1.846 x 1.968				
15500034 (530R)	2 1/16" 1.965 x 2.087				

Oetiker Double Eared Pinch Clamps

Great for Samller diameter hose under 3/4" installs faster, holds and seals better than Bandit style

2-Ear Pinch Clamp zinc plate	Nom. Size x Size Range inches					
10100000 (0041)	5/32" .122 x .161					
10100001 (0045)	11/64" .138 x .177					
10100002 (0305)	3/16" .118 x .197					
10100004 (0507)	1/4" .197 x .276					
10100008 (0709)	5/16" .276 x .354					
10100011 (0811)	3/8" .315 x .433					
10100016 (1113)	1/2" .433 x .512					
10100019 (1315)	9/16" .512 x .591					
10100022 (1517)	19/32" .544 x .669					
10100024 (1518)	5/8" .591 x .708		Great for Spray hose 1-clamp 600psi 2-clamps 1100psi			
10100027 (1720)	3/4" .669 x .787					
10100029 (1922)	13/16" .748 x .866					
10100030 (2023)	7/8" .787 x .905					
10100032 (2225)	15/16" .866 x .984					
10100034 (2327)	1" .905 x 1.063					
10100035 (2528)	1 1/16" .984 x 1.102					
10100037 (2731)	1 1/8" 1.063 x 1.220					
10100041 (3134)	1 5/16" 1.220 x 1.339					
10100043 (3437)	1 7/16" 1.339 x 1.457					
10100045 (3740)	1 1/2" 1.457 x 1.575					
10100047 (4043)	1 5/8" 1.575 x 1.693					
10100049 (4346)	1 3/4" 1.693 x 1.811					



Great for Samller diameter hose under 3/4" installs faster, holds and seals better than Bandit style



2-Ear Pinch Clamp Stainless S	Nom. Size x Size Range inches					
15100000 (0041R)	5/32" .122 x .161					
15100001 (0045R)	11/64" .138 x .177					
15100002 (0305R)	3/16" .118 x .197					
15100003 (04						
15100004 (0507R)	1/4" .197 x .276					
15100006						
15100007						
15100008 (0709R)	5/16" .276 x .354					
15100009						
15100010						
15100011 (0811R)	3/8" .315 x .433					
15100012			Great for Spray hose 1-clamp 600psi 2-clamps 1100psi			
15100013						
15100014						
15100015						
15100016 (111R3)	1/2" .433 x .512					
15100018						

Oetiker Pinch Clamp Tools

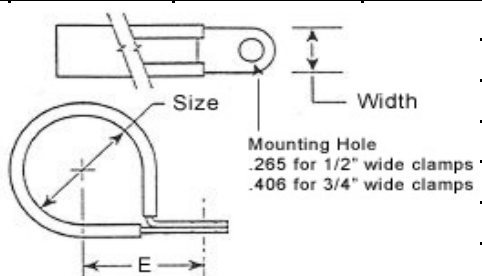
PART #					
14100118	Straight Jaw Pincher				
14100117	Narrow Straight Jaw Pin				
14100083	Side Jaw Pincher				
14100084	Long Handle Pincher				

Cushioned Clamps for Mounting/Routine of Tubing, Wiring, Hose Etc.

Part #	HOLDING DIA.					
SPN-3	3/16" (4.8)					
SPN-4	1/4" (6.4)					
SPN-5	5/16" (7.9)					
SPN-6	3/8" (9.5)					
SPN-7	7/16" (11.1)					
SPN-8	1/2" (12.7)					
SPN-9	9/16" (14.30)					
SPN-10	5/8" (15.9)					
SPN-11	11/16" (17.5)					
SPN-12	3/4" (19.1)					
SPN-14	7/8" (22.2)					
SPN-16	1" (25.4)					
SPN-18	1-1/8" (28.6)					
SPN-20	1-1/4" (31.8)					
SPN-22	1-3/8" (34.9)					
SPN-24	1-1/2" (38.1)					

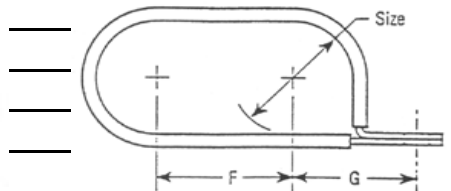

SPN-26	1-5/8" (41.3)					
SPN-28	1-3/4" (44.5)					
SPN-30	1-7/8" (47.6)					
SPN-32	2" (50.8)					
SPN-34	2-1/8" (54.0)					
SPN-40	2-1/2" (63.5)					
SPN-48	3" (76.2)					
3/4 Wide W/.406 bolt hole	HOLDING DIA.					
SPW-4	1/4"					
SPW-6	3/8"					
SPW-8	1/2"					
SPW-10	5/8"					
SPW-12	3/4"					
SPW-14	7/8"					
SPW-16	1"					
SPW-18	1-1/8"					
SPW-20	1-1/4"					
SPW-24	1-1/2"					
SPW-28	1-3/4"					
SPW-32	2"					
SPW-40	2-1/2"					
SPW-48	3"					
						
PART #	SIZE		F	G		
SPD-8	1/2"	0.5	0.764			
SPD-12	3/4"	0.75	0.889			
SPD-14						
SPD-16	1"	1	1.014			
SPD-20	1-1/4"	1.125	1.159			
SPD-24	1-1/2"					
SPD-28	1-3/4"					
SPD-32	2"					



Clamps-Mounting Polypropylene W/Steel Weld Plate

Standard Series Pipe Sized Sets	Pipe Size	Hose Size			
SDP-4	1/4"	2w-4			
SDP-6	3/8"	2w-6			
SDP-8	1/2"	2w-8			
SDP-12	3/4"	2w-12			
SDP-16	1"	2w-16			
SDP-20	1 1/4"	2w-20			
SDP-24	1 1/2"	2w-24			
Standard Series Tube Sized Sets	Tube Size O.D.				
SDT-4	1/4"				
SDT-6	3/8"				
SDT-8	1/2"				
SDT-10	5/8"				
SDT-12	3/4"				
SDT-16	1"				
SDT-20	1 1/4"				
SDT-24	1 1/2"				
SDT-32	2"				
Heavy Duty Series Pipe Sized Sets	Pipe Size	Hose Type	Hose Type	Hose Type	
HDP-4	1/4"	2w-4			
HDP-6	3/8"	2w-6			
HDP-8	1/2"	2w-8		4w-6	
HDP-12	3/4"	2w-12	R4-12		
HDP-16	1"	2w-16	R4-16		
HDP-20	1 1/4"	2w-20	R4-20		
HDP-24	1 1/2"	2w-24	R4-24		
HDP-32	2"	2w-32	R4-32	4w-24	
HDP-40	2 1/2"		R4-40	4w-32	
HDP-48	3"		R4-48		
HDP-56	3 1/2"		R4-56		
HDP-64	4"		R4-64		
HDP-72	4 1/2"				
HDP-80	5"		OIL-SUCT-5"		
HDP-96	6"		OIL-SUCT-6"		

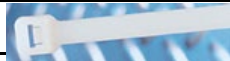
Heavy Duty Series Tube Sized Sets		Tube Size O.D.	Hose Type		
HDT-4		1/4"			
HDT-6		3/8"			
HDT-8		1/2"			
HDT-10		5/8"			
HDT-12		3/4"			
HDT-16		1"	4w-8		
HDT-20		1 1/4"	4w-12		
HDT-24		1 1/2"	4w-16		
HDT-32		2"	4&6w-20		
HDT-40		2 1/2"	6w-24		
HDT-48		3"	6w-32		
Twin Series Pipe Sized Sets		Pipe Size	Hose Type	Hose Type	Hose Type
HZP-4					
HZP-6		3/8"	2w-6		
HZP-8		1/2"	2w-8		4w-6
HZP-12		3/4"	2w-12	R4-12	
HZP-16		1"	2w-16	R4-16	
HZP-20		1 1/4"	2w-20	R4-20	
Twin Series Tube Sized Sets		Tube Size O.D.	Hose Type		
HZT-4		1/4"			
HZT-6		3/8"			
HZT-8		1/2"			
HZT-10		5/8"			
HZT-12		3/4"			
HZT-16		1"	4w-8		
HZT-20		1 1/4"	4w-12		
HZT-24		1 1/2"	4w-16		
CABLE TIES (UV)			BLACK		
Part #		LGTH	LB		QTY
AL-04-18-0-C		4.1"	18.000		100
AL-04-18-0-M		4.1"	18.000		1000
AL-05-40-0-C		5.8"	40.000		100
AL-06-18-0-C		6.1"	18.000		100
AL-06-18-0-M		6.1"	18.000		1000
AL-07-50-0-C		7.5"	50.000		100
AL-07-50-0-M		7.5"	50.000		1000
AL-08-18-0-C		8.1"	18.000		100
AL-08-18-0-M		8.1"	18.000		1000
AL-08-40-0-C		8.8"	40.000		100
AL-08-40-0-M		8.8"	40.000		1000
AL-08-120-0-C		8.7"	120.000		100
AL-11-50-0-C		11.2"	50.000		100
AL-11-50-0-D		11.2"	50.000		500
AL-14-50-0-C		14.5"	50.000	100	
AL-14-50-0-D		14.5"	50.000	500	
AL-14-120-0-C		15"	120.000	100	

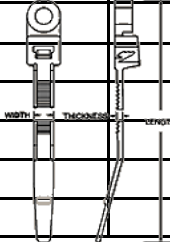

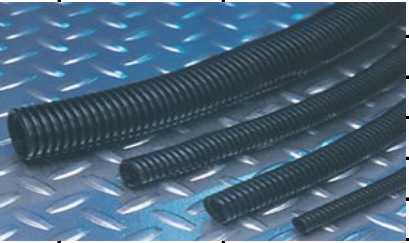
AL-14-120-0-L		15"	120.000		50
AL-18-120-0-C		17.7"	120.000		100
AL-24-175-0-L		25.2"	175.000		50
AL-36-175-0-L		37.2"	175.000		50
AL-48-175-0-L		48.5"	175.000		50
CABLE TIES			Natural		
Part #		LGTH	LB		QTY
AL-04-18-9-C		4.1"	18.000		100
AL-04-18-9-M		4.1"	18.000		1000
AL-05-40-9-C		5.8"	40.000		100
AL-07-50-9-C		7.5"	50.000		100
AL-07-50-9-M		7.5"	50.000		1000
AL-08-40-9-C		8.1"	40.000		100
AL-08-40-9-M		8.1"	40.000		1000
AL-08-120-9-C		8.7"	120.000		100
AL-11-50-9-C		11.2"	50.000		100
AL-11-50-9-D		11.2"	50.000		500
AL-14-50-9-C		14.5"	50.000		100
AL-14-50-9-D		14.5"	50.000		500
AL-14-120-9-C		15"	120.000		100
AL-14-120-9-L		15"	120.000		50
AL-18-120-9-C		17.7"	120.000		100
AL-24-175-9-L		25.2"	175.000		50
AL-36-175-9-L		37.2"	175.000		50
AL-48-175-9-L		48.5"	175.000		50
CABLE TIES		Mounting Hole	BLACK		
Part #		LGTH	LB		QTY
AL-05-30-MH-0-C		5"	30.000		100
AL-07-50-MH-0-C		7"	50.000		100
AL-11-50-MH-0-C		11"	50.000		100
AL-14-50-MH-0-C		14"	50.000		100
AL-14-120-MH-0-C		14"	120.000		100
Mounting Pad 100-Rubber based					QTY
AL-MP-750-0-C		3/4"	Black UV		100
AL-MP-1000-0-C		1"	Black UV		100
AL-MP-750-9-C		3/4"	Natural		100
AL-MP-1000-9-C		1"	Natural		100

Split Loom-UV Black Polyehy		I.D.			LGTH	
AL-SLPE-250-0-C		1/4"			100'	
AL-SLPE-250-0-B		1/4"			3200'	
AL-SLPE-375-0-C		3/8"			100'	
AL-SLPE-375-0-B		3/8"			1900'	
AL-SLPE-500-0-C		1/2"			100'	
AL-SLPE-500-0-B		1/2"			1200'	
AL-SLPE-625-0-C		5/8"			100'	
AL-SLPE-625-0-B		5/8"			800'	
AL-SLPE-750-0-C		3/4"			100'	
AL-SLPE-750-0-B		3/4"			500'	
AL-SLPE-1000-0-C		1"			100'	
AL-SLPE-1000-0-B		1"			300'	
AL-SLPE-1250-0-B		1 1/4"			250'	
AL-SLPE-1500-0-B		1 1/2"			150'	
Cable-Tubing-Hose Wrap-Forward Cut Polyethylene						
BLACK		I.D. / Wall		LGTH	Min-Max Bundle in.	
AL-CWP-125-0-C		.125		100'	1/8 to 1/2	
AL-CWP-187-0-C		.187		100'	3/16 to 11/2	
AL-CWP-250-0-C		.250		100'	1/4 to 2	
AL-CWP-375-0-C		.375		100'	3/8 to 3	
AL-CWP-500-0-C		.500		100'	1/2 to 4	
AL-CWP-625-0-C		.625		100'	5/8 to 4 1/2	
AL-CWP-750-0-C		.750		100'	3/4 to 5	
AL-CWP-1000-0-C		1.00		100'	1 to 7	
CLEAR		O.D.		LGTH	Bundle in.	
AL-CWP-125-9-C		.125		100'	1/8 to 1/2	
AL-CWP-187-9-C		.187		100'	3/16 to 11/2	
AL-CWP-250-9-C		.250		100'	1/4 to 2	
AL-CWP-375-9-C		.375		100'	3/8 to 3	
AL-CWP-500-9-C		.500		100'	1/2 to 4	
AL-CWP-625-9-C		.625		100'	5/8 to 4 1/2	
AL-CWP-750-9-C		.750		100'	3/4 to 5	
AL-CWP-1000-9-C		1.00		100'	1 to 7	