



A-1 INDUSTRIAL SUPPLY TRANSPORTER'S CHOICE



Hose Fittings Valves Flanges Pipe Water Truck Parts

Committed to Our Customers

5 CAMPBELL DRIVE
HERMISTON, OR. 97838
Toll Free 877-385-3125
Ph# 541-564-7636
Fax: 541-564-6522





6756 Supply Way
Boise, ID. 83716
Ph# 208-345-3844
Fax: 208-345.3790







Transporter's Choice



PREMIUM USA VALVES

Part#	Dealer Pricing		
<p>101-2-2.5-FPT-3GRV-AL-USA PREMIUM, Aluminum inline diaphragm valve 3" grooved outside and 2 1/2" female NPT on the inside. Air operated, normally open. 7 to 10psi to open, 176 GPM.</p>			
<p>101-2-2-FPT-3GRV-AL-USA PREMIUM, Aluminum inline diaphragm valve 3" grooved outside and 2" female NPT on the inside. Air operated, normally open. 7 to 10psi to open, 176 GPM.</p>			
<p>101-323-GRV-AL-USA PREMIUM, aluminum inline diaphragm valve 3" grooved ends. Air operated, normally open, 7 to 10 psi to open, 176 GPM</p>			
<p>101-323-GRV-AL-PT-USA PREMIUM, aluminum inline diaphragm valve 3" grooved ends. PORTED, Air operated, normally open, 7 to 10 psi to open, 176 GPM</p>			
<p>101-CAP-AL-USA PREMIUM, aluminum replacement cap for the 101-XXX-AL-USA</p>			

IMPORT VALVES

<p>101-323-GRV-AL-Import Inline Diaphragm Valve 3" grooved 2" body aluminum, 176gpm.c. Normally open. 7 to 10psi to open. 176GPM</p>			
<p>101-323-GRV-AL-PT Inline Diaphragm Valve 3" grooved 2" body aluminum ported, 176gpm.c, 3-way solenoid & air operated. Normally open. 7 to 10psi to open. 176GPMc</p>			
<p>101-2"-GRV-AL-PT Inline Diaphragm Valve 2" grooved aluminum ported, 176gpm.c, 3-way solenoid & air operated. Normally open. 7 to 10psi to open. 176GPMc</p>			
<p>101-323"-GRV-ST Inline Diaphragm Valve 3" Vic grooved 2" body Steel, 176gpm.c, Air operated only. Normally Open.</p>			

101-323"-GRV-ST-PT
 Inline Diaphragm Valve 3" grooved 2" body Steel ported, 176gpm.c, 3-way solenoid & air operated. Normally open. 7 to 10psi to open. 176GPMc



101-2"-GRV-ST-PT Inline Diaphragm Valve 2" grooved Steel ported, 176gpm.c, 3-way solenoid & air operated. Normally Open.



101-2-NPT-AL-PT
 Inline Diaphragm Valve 2" FNPT Aluminum ported, 176gpm.c, 3-way solenoid & air operated) Normally open. 7 to 10psi to open. 176GPMc



101-323-NPT-ST Inline Diaphragm Valve 3" FNPT 2" body Steel, 176gpm.c, Air operated) Normally open.



101-323-NPT-ST-PT Inline Diaphragm Valve 3" FNPT Steel ported, 176gpm, 3-way solenoid & air operated. Normally open. 7 to 10psi to open. 176GPMc



101-2-NPT-ST-PT Inline Diaphragm Valve 2" FNPT Steel ported, 176gpm, 3-way solenoid & air operated. Normally open. 7 to 10psi to open. 176GPMc



G101-500BPSI
 Rubber Diaphragm gasket for 101 Valve to 233wpsi



101-SPRING AND BUTTON
 SPRING AND PLASTIC BUTTON FOR 101 PORTED VALVES



Elbows and Spray Heads

102 Elbow 3" grooved aluminum Note! 102 is a higher flow, longer Elbow than Standard Vic Style, allows for more adjustment with 103 Spray Head



103 Adjustable slip on Deflector Splash Head aluminum.



104 Spray Head Straight Outlet Vic Grooved aluminum.

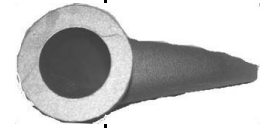

105 Foot Valve 3" hose barb aluminum works in shallow streams.



106 Spray Head Elbow Outlet 3" aluminum Grooved



110 3" Adjustable Fan spray nozzle, Grooved Aluminum (Adjustable)



111 3" Side spray head 1/4" x 5" Slot, Grooved Aluminum.



112 3" Flusher nozzle 3/32" x 7" Slot, Grooved Aluminum.



Steel Splash Head

SPLASHHEAD-2-MPT

SPLASHHEAD-2 1/2-MPT

SPLASHHEAD-3-MPT

SPLASHHEAD-2-GRV

SPLASHHEAD-2 1/2-GRV

SPLASHHEAD-3-GRV



	Flow (GPM)					
	Model					
Pressure (PSI)	104	106	108	110	111	112
20	260	320	315	420	220	285
30	320	360	360	480	260	345
40	360	405	395	515	300	390
50	415	450	435	560	330	450
60	470	485	455	630	360	500
70	505	505	500	680	400	545
80	525	550	525	750	425	575

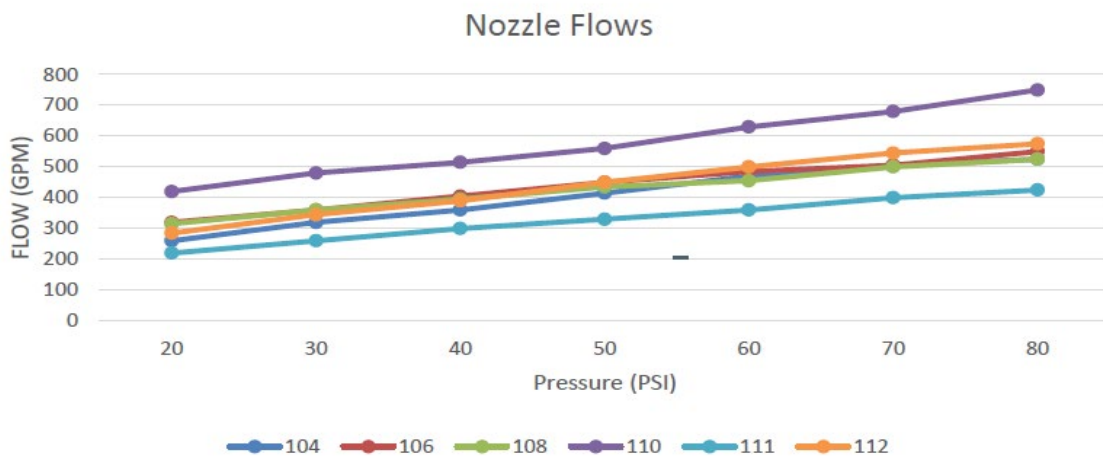

SPRAY CAP

slotted spray head

SPRAYCAP-2

SPRAYCAP-2 1/2

SPRAYCAP-3

SPRAYCAP-MPT-2x4

Cap w/4"nipple

Not Tightened

SPRAYCAP-MPT-2 1/2x4

Cap w/4"nipple

Not T

SPRAYCAP-MPT-3x4

Cap w/4"nipple

Not T

SPRAYCAP-GRV-2

Cap w/GV-nipple, Not Tightened







SPRAYCAP-GRV-2 1/2





















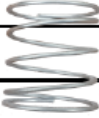

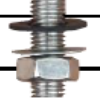
Cap w/GV-nipple, Not Tightened







SPRAYCAP-GRV-3







Cap w/GV-nipple, Not Tightened



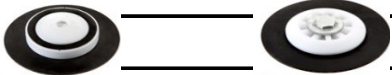







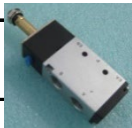

ELBOWS		
ELBOW-90-2B (black)		
ELBOW-90-21/2B		
ELBOW-90-3B		
ELBOW-90-2G (galvanized)		
ELBOW-90-21/2G		
ELBOW-90-3G		
107-A 90 Valved, 4" Inlet Grooved x 3" GRV outlet aluminum Normally closed, air to open. Use GV-4-3-RCP-E to attach to 3"		
108-INLINE-VALVE-ATP NORMALLY CLOSED, inline valve, air to open. 3' groove connections.		
108-ASSY Integral Adjustable Spray Head Valve 3" Vic grooved, Normally closed, air to open.		
108-ASSY Integral Adjustable Spray Head Valve 3" Vic grooved, Normally closed, air to open.		

<p>108-ASSY Integral Adjustable Spray Head Valve 3" Vic grooved, Normally closed, air to open.</p>		
<p>108-REPAIR-I.KIT ball, poppet, spring, diaphragm, nuts, and washers</p>		
<p>108-POPPET-KIT poppet, spring, ball, nuts, washers, (diaphragm not included)</p>		
<p>108-Ball</p>		
<p>108-Band</p>		
<p>108-Cap</p>		
<p>108-Clamp</p>		
<p>108-Diaphragm</p>		
<p>108-Poppet</p>		
<p>108-Spring</p>		
<p>108-NUT-HEX-SS</p>		
<p>108-NUT-NYLOCK</p>		
<p>108-WASHER-SS</p>		
<p>108-DB-1/4x41/2"</p>		
<p>108-DB-3/16x61/2"</p>		
<p>108-DB-5/16x31/2"</p>		
<p>108-4" Integral Adjustable Spray Head Valve 4" Vic grooved Normally closed, air to open. 25% more flow 108</p>	<p>Side spray attachment for 108</p> 	
<p>108-4"-Ball</p>		
<p>108-4"-Poppet</p>		
<p>108-4"-Spring</p>		
<p>108-4"-Diaphragm</p>		







<p>109 Air Actuated Air Valve (90) for spray heads) Normally open air to close.</p>			
<p>109 Replacement parts</p>			
<p>109-Diaphragm</p>			
<p>109-Ball-Half</p>			
<p>109-Cap</p>			
<p>109-Locator-Nut</p>			
<p>109-Repair-Kit</p>	<p>Ball-Diaphragm-Spring-Locator</p>		
<p>109-Spring</p>			
<p>113-3 MEGA/AGM style spray head, 3", with adjustable spray pattern</p>			
<p>113-3-HYD Hydraulic Version of the MEGA/AGM style spray head, 3", with adjustable spray pattern</p>			
<p>115-3-GV 3" MINI VERSION OF 113 WITH Grooved inlet port Aluminum</p>	 		
<p>115-3GV-2.5FPT 3" MINI VERSION OF 113 WITH 3" Grooved and 2 1/2" NPT threaded inlet port Aluminum</p>			
<p>115-3-DIAPHRAGM</p>			
<p>115-3-DIAPHRAGM-KIT</p>			
<p>113-3-AGM-ADAPTER-PLATE</p>			
<p>113-3-DIAPHRAM</p>			
<p>113-3-KNOB</p>			
<p>113-3-MOUNTING PLATE</p>			
<p>113-3-O-RING</p>			
<p>113-HYD-CYLINDER</p>			
<p>113-MOUNTING-BOLT</p>			
<p>113-MOUNTING-BOLT-WASHER</p>			

<p>CRA-2-Valve-DI 2" inline valve FNPT Full Flow, Heavy Duty 200gpm Ductile Iron Body</p>			
<p>CRA-2-Spring</p>			
<p>CRA-2-Diaphragm-A</p>			
<p>CRA-2-Diaphragm-Kit</p>			
<p>CRA-2.5-Diaphragm-A</p>			
<p>CRA-2.5-Diaphragm-Kit</p>			
<p>CRA-2.5-Seat</p>			
<p>CRA-3-Valve-U 3" inline valve, UNPAINTED FNPT Full Flow, Heavy Duty 400gpm Ductile Iron Body.</p>			
<p>CRA-3-Valve-P 3" inline valve, PAINTED FNPT Full Flow, Heavy Duty 400gpm Ductile Iron Body</p>			
<p>CRA-3-Valve-Z 3" inline valve, ZINC COATED FNPT Full Flow, Heavy Duty 400gpm Ductile Iron Body</p>			
<p>CRA-3-VALVE-HYD-P 3" inline valve, ZINC COATED FNPT Full Flow, Heavy Duty 400gpm Ductile Iron Body</p>			
<p>CRA-3-SPRING Replacement spring</p>			
<p>CRA-3-SEAT Small rubber spring seat</p>			
<p>CRA-3-DIAPHRAM</p>			
<p>CRA-3-Diaphragm-Kit</p>			



AGM REPLACEMENT PARTS

AGM-TOGGLE-SWITCH 12/24 Volt Electric Toggle Switch	 	
AGM-SOLENOID-N/O Electric Solenoid valve-Normally Open		
AGM-SOLENOID-N/C Electric Solenoid valve- Normally Closed		
AGM-SOLENOID-DA Electric Solenoid Valve-Double Action		
AGM-COIL-12V		
AGM-COIL-24V		
AGM-VALVE-REPAIR-KIT		
AGM-VALVE-DIAPHRAM		
AGM-VALVE-RUB-SEAT		
AGM-VALVE-SPRING		

GROOVED BUTTERFLY VALVES

BFV-B-GVNL-2.5-GY		
BFV-NSF-GVEL-3-BL		
BFV-NSF-GVEL-4-BL		
VALVE KITS		
101-323-AL-103SHEA Splash head Elbow kit: Includes 101-323-GRV-AL, 102, 103, (1)GV-3-CP-R-E		
101-323-ST-103SHEA	Same as above but with Steel valve	
Above valve, parts come separate. If you want them assembled, with push to connect fittings, add -A to part #		
101-323-AL-104SOA Spray outlet assy Includes: 101-323-GRV-AL, 104, (1)GV-3-CP		
101-323-ST-104SOA	Same as above but with Steel valve	
Above valve, parts come separate. If you want them assembled, with push to connect fittings, add -A to part #		

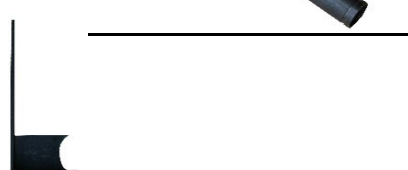
<p>101-323-AL-104SOEA Spray outlet Elbow Assy kit Includes: 101-323-GRV-AL, 104, 102, (2)GV-3-CP-R</p>		
<p>101-323-ST-104SOEA</p>	<p>Same as above but with Steel valve</p>	
<p>Above valve, parts come separate. If you want them assembled, with push to connect fittings, add -A to part #</p>		
<p>101-323-AL-106SEA Spray Elbow Assy Includes: 101-323-GRV, 102, 106, (2) GV-3-CP-R-E</p>		
<p>101-323-ST-106SEA</p>	<p>Same as above but with Steel valve</p>	
<p>Above valve, parts come separate. If you want them assembled, with push to connect fittings, add -A to part #</p>		
<p> </p>		
<p>108-Elbow Assy Integral Spray Head valve 3" Vic grooved Includes:108, GV-90-3, GV-3-CP, QEV-set</p>		
<p>Above valve, parts come separate. If you want them assembled, with push to connect fittings, add -A to part #</p>		
<p>108-DBSOEA Duckbill side spray assy. Includes: 108, 108-DB-1/4x4.5, GV-3-CP-R,QEV+</p>		
<p>Above valves assembled with push to connect fitting add -A to part# &</p>		
<p>109-110ASHA Adjustable spray head assy includes 109, 110, 1-GV-3-CP-R, QEV+</p>		
<p>Above valve, parts come separate. If you want them assembled, with push to connect fittings, add -A to part #</p>		
<p>109-111SOEA 109 side spray assy. Includes 109, 111, 1-GV-3-CP-R, QEV+</p>		
<p>CRA-3-104SOEA</p>		
<p>Above valve, parts come separate. If you want them assembled, with push to connect fittings, add -A to part #</p>		

Plumbing-FSB-3"X40"-Sch40BIP Front Spray Bar, 3", groove x groove, (brackets not included)			
Plumbing-RSB-3"X48"Sch40Bip Rear Spray Bar, 3", groove x groove, (brackets not included)			
PLUMBING-FSB-BRACKET Front spray bar bracket, for 3" pipe, (need 2 to mount spray bar)			
PLUMBING-RSB-BRACKET Rear Spray Bar bracket, for 3" pipe, (need 2 to mount spray bar)			

CONTROL TOWERS-IN CAB These towers come in 3 heights, 12", 16", 20". They are 7" x 7" square. They are fully plumbed with switches installed and airline 18" out

MAKE SURE AND SPECIFY IF THE VALVES TO BE OPERATED ARE NORMALLY OPEN OR CLOSED WITH "NO" OR "NC" IN THE PART #

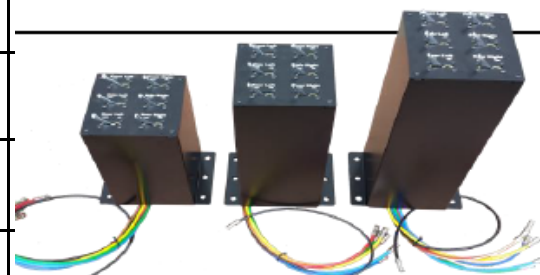
KWIK-E-TOWER-5-12T-NO			
KWIK-E-TOWER-5-12T-NO-DOT			
KWIK-E-TOWER-5-16T-NO			
KWIK-E-TOWER-5-16T-NO-DOT			
KWIK-E-TOWER-5-20T-NO			
KWIK-E-TOWER-5-20T-NO-DOT			
KWIK-E-TOWER-6-12T-NO			
KWIK-E-TOWER-6-12T-NO-DOT			
KWIK-E-TOWER-6-16T-NO			
KWIK-E-TOWER-6-16T-NO-DOT			
KWIK-E-TOWER-6-20T-NO			
KWIK-E-TOWER-6-20T-NO-DOT			

- **Tower Dimensions**
 - 12", 16" and 20" Tall
 - 7" x 7" Square
 - 2 Mounting Legs 1 1/2" x 7" 6 Mounting Holes, 1/2"
- **Features**
 - Powder Coated Exterior
 - Silk Screen Labels
 - Removable Top Plate
 - Reversible Switch Mounting
- These towers will have air lines (pigtailed) installed.
- Each pigtail will have 18" of length out the bottom of the tower, and have a union coupler on it for easy installation. This will also give you a great break point to replace any air lines that get damaged in the future.
- The pigtailed are color coded to their switch for quick identification.
- You will have the option of having your Logo screen printed on the top plate, with volume orders.

SPRING-MOUNTS
TIE DOWN SPRINGS FOR TRUCK BODIES.



TANK-SOUNDSTRIPS-21/2X48
Rubber pads, with steel backing, for cushion between the tank and the truck frame. Can be welded directly to tank sub-frame.



WLA300-A12
TANK VISION GAUGE, PRIMARY KIT WITH GREEN FULL INDICATOR. COMES WITH SENSOR AND CABLES

WLA300-A03-S30

KIT WATER DISP TANKVISION WLA300-A12 WITH A 30' HARNESS

WLA205-A00

Water display, TankVision, Cab Mini

WLA280-A00

MAXVISION LED DISPLAY, COMES WITH 1) XE-WL280-D0A DISPLAY, 1) XE-WLA2PM-R0A REF PROD MANUAL TANK VISION, AND 1) XE-XXDLTERMW-A0A ACCY DATA-LINK TERM RES W/WIRES

TANKVISION

FEATURES

- Nine Highly Visible Ultra-Bright LEDs Provide the Most Accurate Display Available
- Wide-Viewing 180° Lens is Easy to See Under All Conditions
- Visual/Audio Warnings for Low Water/Foam Volume
- Self-Calibrates to Any Size/Shape Tank Making it Easy to Install and Operate
- Pressure Sensor Monitors Water/Foam Volume Which Means no Tank Probes to Install or Maintain
- Unlimited Remote Displays Including Cab Miniature
- Water/Foam Volume Visible from Multiple Locations
- Remote Light Driver Powers Four 60 Watt Remote Lights or LED Light Stick
- Waterproof Cast Aluminum Housing is Dependable and Proven Reliable

Now Available with Chrome Bezel

Cab Miniature

SEE MONITOR CATALOG

SEE MONITOR CATALOG

SEE MONITOR CATALOG

SEE MONITOR CATALOG

XE-WLPT-S0A TANK VISION SENDING UNIT



SEE MONITOR CATALOG

XE-WLS200S-C30A

CABLE TANK VISION SENSOR 30FT

SEE MONITOR CATALOG

RVS-CAMERA-SYSTEM-1C
WIRELESS BACKUP CAMERA SYSTEM, COMES WITH ONE CAMERA



SEE MONITOR CATALOG

RVS-CAMERA-ONLY
WIRELESS BACKUP ADD ON CAMERA. THIS IS A CAMERA ONLY TO ADD TO THE ABOVE KIT FOR DUAL DISPLAY



SEE MONITOR CATALOG

RVS-082507
RVS REAR CAMERA SYSTEM, WIRED



SEE MONITOR CATALOG

MANSERVER-BARS
MANSERVER BARS, 14" through 36". must specify length when ordering. cost is the same for all lengths. price per one bar



SEE MONITOR CATALOG

QEV-90-1/8-FPT
 Quick exhaust valve for air exhaust,
 on 108/109 for better performance.



QEV-90-1/8-FPT-SET
 Quick exhaust valve for air exhaust
 on 108/109 for better performance.
 Ready to install.



PT-1/8
 Air Control Flipper valve On-
 Off Two position chrome plated
 steel handle.



Toggle-Air-Switch-3/2-1/8
 Compact Air Toggle Switch. 3/2
 Cuts off the flow and vents to the
 Atmosphere. 1/8 mpt x 1/4 tube
 fitting.

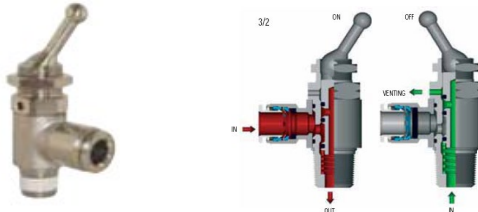

Toggle-3way-Switch-1/8



Toggle-4way-Switch-1/8



CYL-Air-2x6"-Side-Spray
 Double acting 2" cyl, 6" stroke, 145psi, NBR

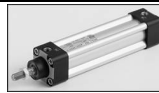

CYL-ROD-EYE





CYL-ROD-FORK



IC62-N-5/32		5/32 tube union	see ptc catalog
IC62-N-2		1/8 tube union	see ptc catalog
IC62-N-4		1/4 tube union	see ptc catalog
IC68-N-5/32x0		5/32"tube x 0-unc-oring seal straight	see ptc catalog
IC68-N-2X2		1/8" tube x 1/8" mpt straight	see ptc catalog
IC68-N-4X2		1/4" tube x 1/8" mpt straight	see ptc catalog
IC68-N-4X4		1/4" tube x 1/4" mpt seal straight	see ptc catalog
IC69-NS-5/32X0		5/32" tube x 0-unc swivel mpt 90	see ptc catalog
IC69-NS-2X2		1/4" tube x 1/8" swivel mpt 90	see ptc catalog
IC69-NS-4X2		1/4" tube x 1/8" swivel mpt 90	see ptc catalog
IC69-NS-4X4		1/4" tube x 1/4" swivel mpt 90	see ptc catalog
IC71-NS-4X2		swivel male run tee 1/4 tube x 1/8mpt	see ptc catalog
IC71-NS-4X4		swivel male run tee 1/4 tube x 1/4mpt	see ptc catalog
IC72-NS-4X2		swivel male branch tee 1/4 tube x 1/8mpt	see ptc catalog
IC72-NS-4X4		swivel male branch tee 1/4 tube x 1/4mpt	see ptc catalog
MW68-NO-2X2		1/8" tube x 1/8" mpt-oring seal straight	see ptc catalog
MW68-NO-5/32x0		5/32"tube x 0-unc-oring seal straight	see ptc catalog
MW68-NO-4X2		1/4" tube x 1/8" mpt-oring seal straight	see ptc catalog
MW68-NO-4X4		1/4" tube x 1/4" mpt-oring seal straight	see ptc catalog
MW69-NSO-5/32X0		5/32" tube x 0-unc swivel mpt-oring seal 90	see ptc catalog
MW69-NSO-4X2		1/4" tube x 1/8" swivel mpt-oring seal 90	see ptc catalog
MW69-NSO-4X4		1/4" tube x 1/4" swivel mpt-oring seal 90	see ptc catalog
IC68-DOT-4X2		D.O.T. 1/4" tube x 1/8" mpt	see ptc catalog
IC68-DOT-4X4		D.O.T. 1/4" tube x 1/4" mpt	see ptc catalog
IC69-DOTS-4X2		D.O.T. 1/4" tube x 1/8" mpt	see ptc catalog
IC69-DOTS-4X4		D.O.T. 1/4" tube x 1/4" mpt	see ptc catalog

SEE FULL CATALOG FOR ALL OUR PUSH TO CONNECT FITTINGS, BRASS, POLY, DOT, ALL SIZES

Polyethylene Tubing Bagged in 100' Order by color- BK, BL, RD, GR, YL, OR			
TUBING-PE-5/32BK-100'		see hose ctlg	see hose ctlg
TUBING-PE-1/8BK-100'		see hose ctlg	see hose ctlg
TUBING-PE-1/4BK-100'		see hose ctlg	see hose ctlg
Polyethylene Tubing in cut lgth's or 1000' rolls. Order by color- BK, BL, RD, GR, YL, OR			
TUBING-PE-5/32BK-1000'		see hose ctlg	see hose ctlg
TUBING-PE-1/8BK-1000'		see hose ctlg	see hose ctlg
TUBING-PE-1/4BK-1000'		see hose ctlg	see hose ctlg

Parker SAE J844 Nylon Airbrake Tubing, 1/8"= 150 wpsi/1,000bps 1/4"=150wpsi/1,000bps Order by color- BK, BL, RD, GR, YL, OR			
TUBING-NAB-1/8BK-1000'		see hose ctlg	see hose ctlg
TUBING-NAB-1/4BK-1000'		see hose ctlg	see hose ctlg

Solenoid Valves for water/air			
SOL-FABCO-12V-3WAY-1/8			
SOLENOID-12VDC-3WAY-1/8			
SOLENOID-12VDC-3WAY-1/4			
SOLENOID-24VDC-3WAY-1/8			
SOLENOID-24VDC-3WAY-1/4			

Replacement Coils for Solenoids			
Solenoid-12VDC-Coil			
Solenoid-24VDC-Coil			
Solenoid-120VDC-Coil			

Electric Toggle Switch			
Toggle-switch-RB-2-Set			
Toggle-switch-Elec-2			
Toggle-Boot			

GROOVE PLUMBING KITS- NO WELDING NEEDED

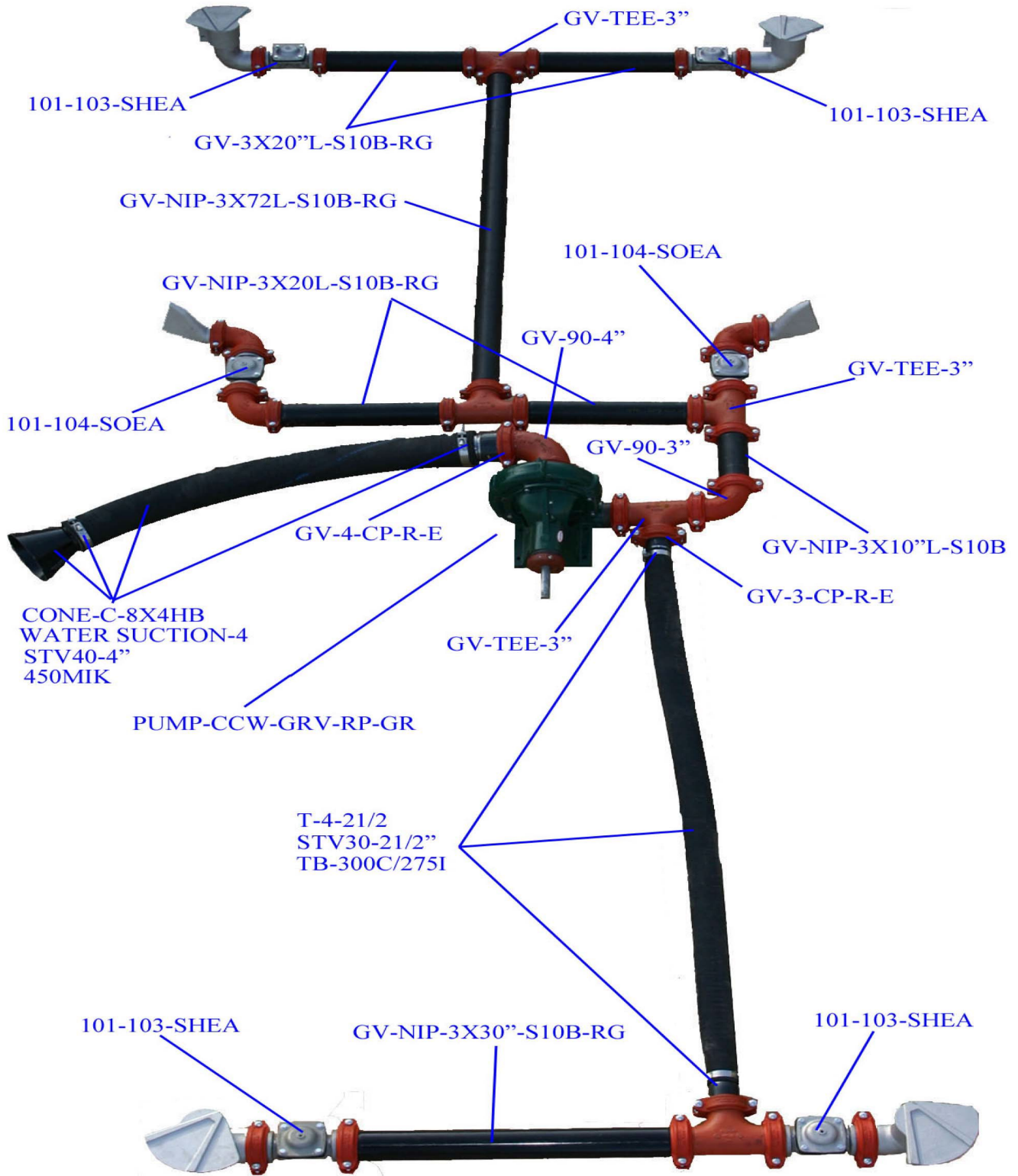

GRV-6 SPRAY-KIT-101 Plumbing kit with all groove connection, includes ALL pipe, pump, clamps, valves, hose, KWIK-E-TOWER, ect. Needed to install a 6 spray system on a water truck with 101 groove inline valves.

SEE PICTURE ABOVE
 (SOME ADJUSTMENTS MAY HAVE TO BE MADE TO FIT YOUR TURCK)

PLUMBING KITS- WELDING REQUIRED

PLUMBING-ID-KIT-3" Inlet-Discharge Kit-includes: pump bracket, weld fittings, hose, fittings and clamps needed to plumb from tank to pump and out to pressure manifold. **For list of parts, request Quote #8389**



PLUMBING-FSB-KIT-3" Front Spray Bar Kit-includes: Pipe, hose, clamps, valves, spray heads and air controls to plumb a spray bar from the pump manifold. **For list of parts, request quote #8384**



PLUMBING-RSB-KIT-3" Rear Spray Bar Kit-includes: Pipe, clamps, valves, spray heads and air controls to plumb a spray bar from the pump manifold. **For list of parts, request quote #8385**



PLUMBING-DSS-KIT-3" Side Spray Kit (Drivers side)includes: weld fittings, valves, spray heads and air controls to plumb a side spray off the pump manifold. **For list of parts, request quote #8386**



PLUMBING-PSS-KIT-3" Additional Side Spray Kit (Passanger side)-includes: pipe, weld fittings, valves, spray heads and air controls to plumb a side spray off the pump manifold. **For list of parts, request quote #8388**



Easily add the ability to Draft to your water truck from a pond, river, pool etc.

Draft-Kit-4x3-GV-Complete
Fits onto your pumps inlet, everything needed to draft from rivers, creeks, ponds etc and fill your tank. Manually operated.



Draft-Kit-4x3-GV Fits onto your pumps inlet, Allows you to draft Manually operated.



Draft-kit-4X3GV-W/pump
Draft kit, with PRIMER PUMP KIT.
Everything you need on the suction side of the pump to complete a selft loading system



Draft-Kit-4x3-GV-Air-Complete Fits onto your pumps inlet, everything needed to draft from rivers, creeks, ponds etc and fill your tank. Air operated just flip a switch from your cab, minimal thought needed to operate..



Draft-Kit-4x3-GV-Air Fits onto your pumps inlet, Air operated just flip a switch from your cab, minimal thought needed.to operate.

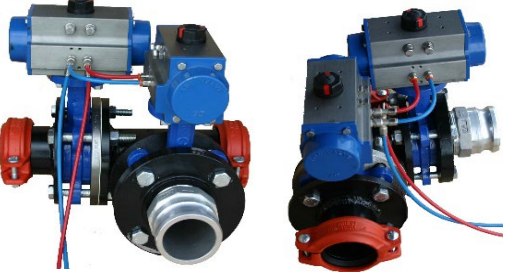

Draft-Tee-4-for Air
Tee for above Air actuated draft kit.



Draft-Kit-3-GV-Air-Complete
Fits onto your pumps inlet, everything needed to draft from rivers, creeks, ponds etc and fill your tank. Air operated just flip a switch from your cab, minimal thought needed.



Draft-Kit-3-GV-Air
Fits onto your pumps inlet, Air operated just flip a switch from your cab, minimal thought needed.



Draft-Tee-3-for Air
Tee for above Air actuated draft kit.



Draft-Tank-to-Pump-hose 4"
hose for making flexible connect between the Tank & the Pump(Grooved end for pump connection.)

















DRAFT-Suc-Hose-#1M-3"x10' 3" Suction Hose (S115-3) W/Horizontal Foot Valve (105) & M Cam10' OVL



DRAFT-Suc-Hose-#1F-3"x10' 3" Suction Hose (S115-3) W/Horizontal Foot Valve (105) & F Cam10' OVL



<p>DRAFT-Suc-Hose-#2-3"x10' 3" Suction Hose (S115-3) W/Horizontal Foot Valve (105) & F Cam10' OVL</p>			
<p>DRAFT Tank-Fill-Hose Use to fill Tank when Drafting Attach to side spray valve or any spray valve/elbow that is grooved/Vic! Throw other end into the tank and fill your tank. 20'Ovl</p>			
<p>Draft Primer Pumps</p>			
<p>#DPPH-5G Pump designed for 2", 3" and 4" pipe or hose size. Will fill a 4" x 25' long suction hose with 10 strokes.</p>			
<p>#DPPH-7G Pump designed for 4", 5" and 6" pipe or hose size. Will fill a 4" x 25' long suction hose with 6 strokes.</p>			
<p>#Draft-Primer-Dp9 Pump designed for 6", 8" or larger pipe or hose size. Will fill a 6" x 25' long suction hose with 10 strokes.</p>			
<p>Draft-Primer-DP5-Kit-tee pump kit includes: pump, bracket, groove tee with hose barb, hose and grv. Clamp</p>			
<p>Draft-Primer-DP5-Kit-nip pump kit includes: pump, bracket, groove tee with hose barb, hose and grv. Clamp</p>			
<p>Draft-Primer-DP7-Kit-NIP</p>	<p>SAME KIT AS ABOVE WITH DP7 PUMP</p>		
<p>Draft-Primer-DP9-Kit-NIP</p>	<p>SAME KIT AS ABOVE WITH DP9 PUMP</p>		
<p>DRAFT-PUMP-ADT-TEE</p>			
<p>DRAFT-PUMP-ADT-NIP</p>			





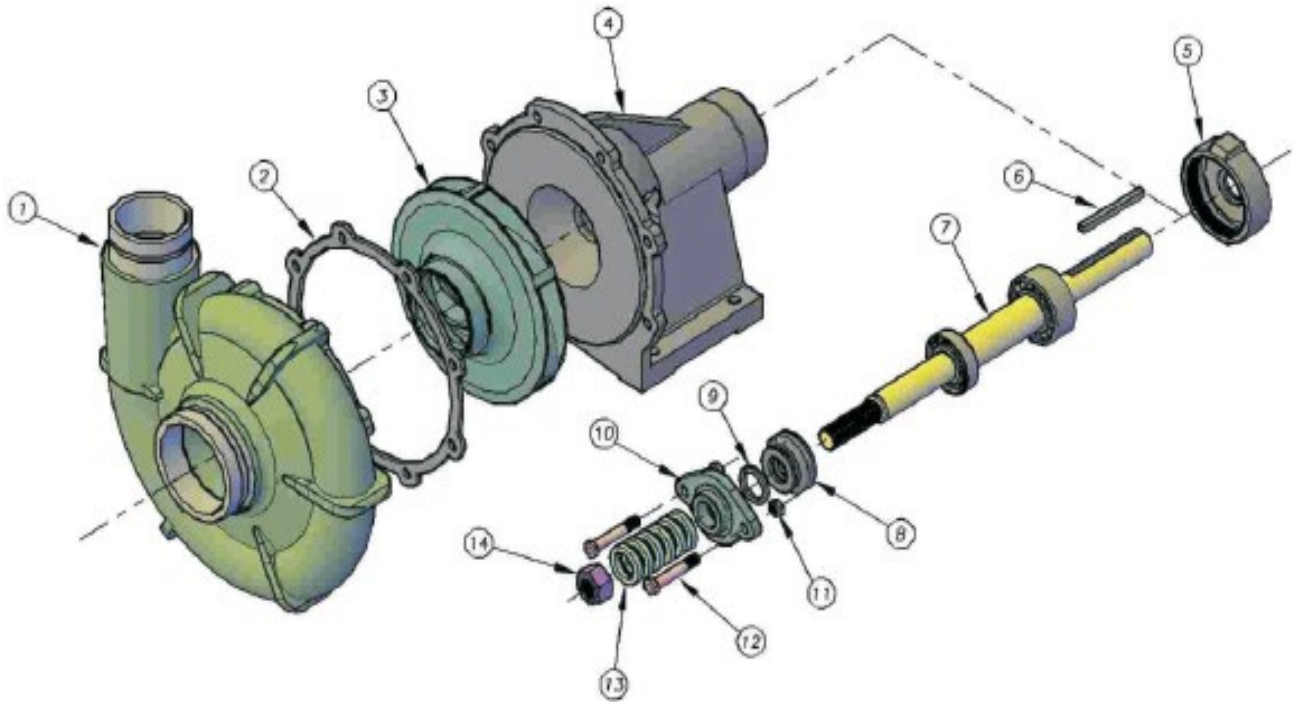





<p>HR-HDCR-11/2x50-ST Hose Reel hand crank handles 50' of 1 1/2 hose. Heavy duty steel frame. Beveled gear for ease of Cranking! Greased bearings!</p>			<p>This reel can be included in dollar amount to make Freight Prepaid Minimum!</p>
<p>HR-HDCR-W/11/2X50'-BK Above reel with 50' of 1 1/2" 250wpsi black water/air hose cpld Mpt x Mpt and installed on reel.</p>			<p>This reel can be included in dollar amount to make Freight Prepaid</p>
<p>HR-HDCR-W/1X100'-BK Above reel with 100' of 1" 300wpsi black water/air hose cpld Mpt x Mpt & installed on reel.</p>			<p>This reel can be included in dollar amount to make Freight Prepaid Minimum!</p>
<p>HR-HDCR-Kit-11/2x50-BK. Ready to install reel kit w/50' of 1 1/2" hose (installed on reel), Nozzle, 5' of feed hose, 2-mpt hose barbs & clamps, tank nipple, Ball Valve & St Elbow.</p>			<p>This reel can be included in dollar amount to make Freight Prepaid Minimum!</p>
<p>HR1-15-1185-CRANK HAND CRANK, medium duty, Holds 50' of 1.5" hose</p>			
<p>SD14050 OLP SPRING REWIND, 1" X 50' REEL ONLY, HOSE SOLD SEPARATE</p>			
<p>FF9600 OLPBW SPRING REWIND CAN HOLD 50' OF 1 1/2", REEL ONLY, HOSE SOLD SEPARATE</p>			
<p>HR-EP7528-19-21-RT HANNAY ELECTRIC HOSE REEL, 1 1/2" X 50, HEAVY FRAME REEL. REEL ONLY, HOSE SOLD SEPARATE</p>			
<p>HR HOSE KITS</p>	<p>INCLUDES HOSE WITH MNPT ENDS, NOZZLE, 5' OF FEED HOSE WITH MNPT ENDS, NIPPLE, BALL VALVE AND NOZZLE</p>		
<p>HR-HOSE-KIT-1"X50'-BK</p>			
<p>HR-HOSE-KIT-1"X100'-BK</p>			
<p>HR-HOSE-KIT-1 1/2"X50'-BK</p>			
<p>HR HOSE ASSEMBLIES</p>	<p>HOSE REEL HOSE ASSEMBLIES, MNPT ENDS</p>		
<p>1-200ER-BK-MPXMPX-50'</p>	<p>1" x 50'</p>		
<p>1-200ER-BK-MPXMPX 100'</p>	<p>1" x 100'</p>		
<p>ER1.5-200BK-MPXMP-CRS-50</p>	<p>1 1/2 x 50'</p>		

Pump Parts













PUMP-VALUTE-CCW-GRV	#1	SEE PUMP CATALOG
PUMP-GASKET	#2	SEE PUMP CATALOG
PUMP-CCW-IMPELLER	#3	SEE PUMP CATALOG
PUMP-3-BASE-#4	#4	SEE PUMP CATALOG
PUMP-OUTER-BEARING-	#5	SEE PUMP CATALOG
Pump-CCW-SHAFT-KIT	Includes # 6,7 and 14	SEE PUMP CATALOG
PUMP-INNER-BEARING-		
CAP	#8	SEE PUMP CATALOG
PUMP-SLINGER	#9	SEE PUMP CATALOG
PUMP-PACKING-GLAND	#10	SEE PUMP CATALOG
PUMP-PACKING-GLAND-	#11	SEE PUMP CATALOG
PUMP-PACKING-GLAN-	#12	SEE PUMP CATALOG
PUMP-PACKING-ROPE-KIT-B	#13	SEE PUMP CATALOG
PUMP-PACKING-ROPE-KIT-M	Rope Packing for Monach NT3M9S	SEE PUMP CATALOG
PUMP-SHAFT-NUT	#14	SEE PUMP CATALOG
PUMP-MECH-SEAL-B	Mechanical Seal for Berkeley B3ZRM	SEE PUMP CATALOG
PUMP-MECH-SEAL-M	Mechanical Seal for Monarch NT3M9S	SEE PUMP CATALOG
PUMP-TO-HYD-ADT Hydraulic Adapter for the Berkeley Pump		SEE PUMP CATALOG

TRANSPORTERS CHOICE PUMPS

<p>PUMP-CCW-GRV-RP-BK B66895, counter clockwise, 4" x 3" grooved with SS shaft, rope packing,112 lbs, 750GPM@2500GPM/60PSI</p>		<p>SEE PUMP CATALOG</p>
<p>PUMP-CCW-GRV-MS-BK B68416, counter clockwise, 4" x 3" grooved with SS shaft, mechanical seal,112 lbs, 750GPM@2500GPM/60PSI</p>		<p>SEE PUMP CATALOG</p>
<p>PUMP-CCW-NPT-RP-BK Berkely style pump, counterclockwise B66168 with rope packing,4" x 3" NPT, with SS shaft, 112 lbs 750GPM@2500GPM/60PSI</p>		<p>SEE PUMP CATALOG</p>
<p>PUMP-CCW-NPT-MS-BK B68415, counter clockwise 4" X 3" NPT connection, with mechanical seal, with SS shaft, 112lbs 750GPM@2500GPM/60PSI</p>		<p>SEE PUMP CATALOG</p>
<p>PUMP-CW-GRV-RP-BK B66899, clockwise, 4" x 3" grooved with SS shaft, rope packing,112 lbs, 750GPM@2500GPM/60PSI</p>		<p>SEE PUMP CATALOG</p>
<p>PUMP-CW-GRV-MS-BK B68417, clockwise 4" x 3" grooved with SS shaft, mechanical seal,112 lbs, 750GPM@2500GPM/60PSI</p>		<p>SEE PUMP CATALOG</p>
<p>PUMP-CW-NPT-RP-BK B66161, clockwise with rope packing,4" x 3" NPT, with SS shaft, 112 lbs 750GPM@2500GPM/60PSI</p>		<p>SEE PUMP CATALOG</p>
<p>PUMP-CW-NPT-MS-BK , B68414 clockwise, 4" X 3" NPT connection, with mechanical seal, with SS shaft, 112lbs 750GPM@2500GPM/60PSI</p>		<p>SEE PUMP CATALOG</p>
<p>PUMP-CCW-NPT-4X4-SP B69876 Berkeley style pump, 4x4 FNPT self priming pump, hydraulic drive, 13 ft head, 9" impeller, clockwise rotation, B-mount included, mechanical seal</p>		<p>SEE PUMP CATALOG</p>
<p>PUMP-BRACKET-CCW-3/8T-10W Pump bracket for mounting pump to truck frame</p>		<p>SEE PUMP CATALOG</p>

BERKELEY PUMPS

<p>PUMP-CCW-GRV-RP-OR B66895, counter clockwise, 4" x 3" grooved with SS shaft, rope packing,112 lbs, 750GPM@2500GPM/60PSI</p>		<p style="text-align: center;">SEE PUMP CATALOG</p>
<p>PUMP-CCW-GRV-MS-OR B68416, counter clockwise, 4" x 3" grooved with SS shaft, mechanical seal,112 lbs, 750GPM@2500GPM/60PSI</p>		<p style="text-align: center;">SEE PUMP CATALOG</p>
<p>PUMP-CCW-NPT-RP-OR Berkely style pump, counterclockwise B66168 with rope packing,4" x 3" NPT, with SS shaft, 112 lbs 750GPM@2500GPM/60PSI</p>		<p style="text-align: center;">SEE PUMP CATALOG</p>
<p>PUMP-CCW-NPT-MS-OR B68415, counter clockwise 4" X 3" NPT connection, with mechanical seal, with SS shaft, 112lbs 750GPM@2500GPM/60PSI</p>		<p style="text-align: center;">SEE PUMP CATALOG</p>
<p>PUMP-CW-GRV-RP-OR B66899, clockwise, 4" x 3" grooved with SS shaft, rope packing,112 lbs, 750GPM@2500GPM/60PSI</p>		<p style="text-align: center;">SEE PUMP CATALOG</p>
<p>PUMP-CW-GRV-MS-OR B68417, clockwise 4" x 3" grooved with SS shaft, mechanical seal,112 lbs, 750GPM@2500GPM/60PSI</p>		<p style="text-align: center;">SEE PUMP CATALOG</p>
<p>PUMP-CW-NPT-RP-OR B66161, clockwise with rope packing,4" x 3" NPT, with SS shaft, 112 lbs 750GPM@2500GPM/60PSI</p>		<p style="text-align: center;">SEE PUMP CATALOG</p>
<p>PUMP-CW-NPT-MS-OR B68414 clockwise, 4" X 3" NPT connection, with mechanical seal, with SS shaft, 112lbs 750GPM@2500GPM/60PSI</p>		<p style="text-align: center;">SEE PUMP CATALOG</p>
<p>PUMP-CCW-NPT-4X4-SP-OR B69876 Berkeley style pump, 4x4 FNPT self priming pump, hydraulic drive, 13 ft head, 9" impeller, clockwise rotation, B- mount included, mechanical seal</p>		<p style="text-align: center;">SEE PUMP CATALOG</p>
<p>BERKLEY PUMP, B4JRMBS, B69743, CW, HYDRAULIC DRIVE, 5" X 4" FLANGE, 13 1/2" IMPELLOR</p>		<p style="text-align: center;">SEE PUMP CATALOG</p>

WE STOCK MANY OTHER BERKELEY PUMPS AS WELL SO PLEASE CALL FOR PRICING

PTO'S			
PTO'S FOR WITH ROUND SHAFT AND 1/4 KEY FOR DRIVELINE			
PTO'S FOR WITH B-MOUNT FOR HYDRAULIC PUMPS			
HYDRAULICS: Motors, Pumps, Valves, Hoses, Kits & Accessories.			
Hydraulic Motors.			
			
Hydraulic Pumps			
			
Hydraulic Valves			
			
Hydraulic Filters			
			
Tank Filler/Filter Caps			
Cap-Fil-3B-40mesh		Tank filler/filter Cap w/3"L 40mesh screen	
Tank Kits			
HYD-TANK-25			
tank only, filter and valve not included.			
Complete Wet Kits: Call for quotes!			



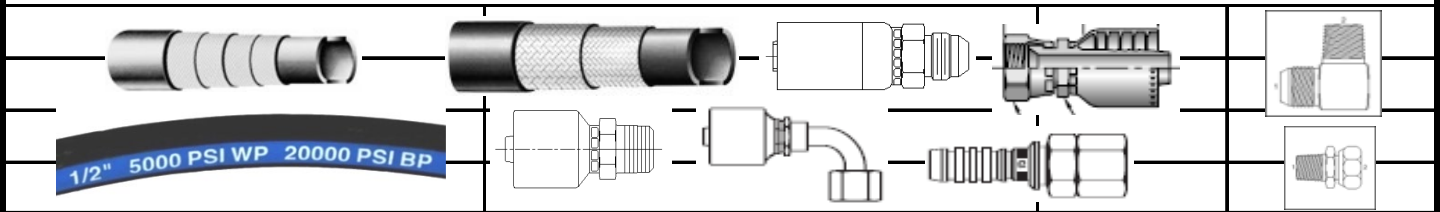

We have a complete and very Competitive Hydraulic hose & Fitting Program!

Gates Fittings & Hose, USA Made Parker, Dayco, Weatherhead Copy fittings

Semperit Hose. Brennan Hyd. Adapters, Flanges & Swivels. Used Crimpers Etc.



<p>Swivel-Straight (pipe thread)Anodized Alum/SS 150WPSI Handles water/fuels etc.</p>			
FOA125MF	male pipe x female pipe 1 1/4"		
FOA150MF	male pipe x female pipe 1 1/2"		
FOA200MF	male pipe x female pipe 2"		
FOA250MF	male pipe x female pipe 2 1/2"		
30MF-SV-AL	male pipe x female pipe 3"		
FOA125FF	female pipe x female pipe 1 1/4"		
FOA150FF	female pipe x female pipe 1 1/2"		
FOA200FF	female pipe x female pipe 2"		
FOA250FF	female pipe x female pipe 2 1/2"		
FOA300FF	female pipe x female pipe 3"		
<p>Swivel 90 degree elbow (pipe thread)Anodized Alum/SS 150WPSI Handles</p>			
FOA125FF-EL-90-A	female pipe x female pipe		
FOA150FF-EL-90-A	female pipe x female pipe		
FOA200FF-EL-90-A	female pipe x female pipe		
FOA250FF-EL-90-A	female pipe x female pipe		
FOA300FF-EL-90-A	female pipe x female pipe		
<p>Swivel 90 degree elbow (pipe thread)Anodized Alum/SS 150WPSI Handles</p>			
FOA125MF-EL-90-A	male pipe x female pipe		
FOA150MF-EL-90-A	male pipe x female pipe		
FOA200MF-EL-90-A	male pipe x female pipe		
FOA250MF-EL-90-A	male pipe x female pipe		
FOA300MF-EL-90-A	male pipe x female pipe		
<p>Swivel-Straight-Short (pipe thread)Chrome plated brass - Anodized Alum,short lgth. 150wpsi Handles water/fuels/fertilzers etc.</p>			
PS34MF	Male pipe x female pipe short swivel 3/4"		
PS100MF	Male pipe x female pipe short swivel 1"		
ZS10MF	Male pipe x female pipe short swivel 1 1/2"		

Swivel-90-Short (pipe thread) Chrome plated brass/Anodized Alum, SS, short lgth. 150WPSI Handles			
PS34FF-90	female pipe x female pipe short swivel 90 3/4"		
PS100FF-90	female pipe x female pipe short swivel 90 1"		
ZS10FF-90	female pipe x female pipe short swivel 90 1 1/2"		
Swivel-Straight (grooved) Anodized Alum/SS 150WPSI Handles water/fuels/fertilizers etc.			
30GGSV-AL	3"grooved x grooved. Use!Actuated side spray		
40GGSV-AL	4"grooved x grooved. Use!Actuated side spray		
Hydrant Fill Hose			
MD250-2.5-FABNST-X-C-20			
MD250-2.5-FABNST-X-C-25			
MD250-2.5-FABNST-X-C-50			
FIRE HOSES			
Medium Duty, Single Jacket	single jacket fire hose, 250 wpsi, 500 tpsi		
MD250-11/2X50-NST			
MD250-11/2X100-NST			
MD250-21/2X50-NST			
MD250-21/2X100-NST			
	ALSO AVAILABLE IN NPSH (NPT)		
Heavy Duty, Double Jacket	double jacket fire hose, 400wpsi, 800tpsi		
DJ600-11/2X50-NST			
DJ600-11/2X100-NST			
DJ600-21/2X50-NST			
DJ600-21/2X100-NST			
	ALSO AVAILABLE IN NPSH (NPT)		

SEE OUR OTHER CATALOGS!

Industrial Hose	Clamps	Flanges-Weld fittings-Flange Adapt	Grooved couplings & fittings		
					
Chain -Sure-flex cplgs	Wheeline -Hydrau	Gauges	Valves	Butterfly Valves	Diaphragm V
					
Pipe Fittings	Pipe Nipples/Half	SS Pipe Fit	Brass Pipe Fittings	Brass Ind fittings	Brass Flare
					
Brass Push to connect	Water Truck Parts	Hydraulic H	Hyd. Adapt	Hydraulic Crimp	Hydraulic Q
					